



## PowerLite<sup>®</sup> 1835 MULTIMEDIA PROJECTOR



### Flexibility, connectivity, brightness, value.

Enhance your presentations in any boardroom or classroom with the PowerLite 1835, designed for affordability and convenience. Images can be adjusted using horizontal and vertical keystone correction, plus the Quick Corner<sup>®</sup> feature to accommodate almost any room setup. You have even more flexibility with a 1.6x optical zoom, which displays images up to 40% larger than competing projectors with a 1.2x optical zoom — without a change in image quality. The PowerLite 1835 features 3500 lumens of color and white light output<sup>1</sup> and XGA resolution, for sharp, vibrant images.

**Flexible setup** — advanced image adjustments, higher tilt and optical zoom

**Comprehensive, future-ready connectivity** — HDMI digital input, USB display, PC-free and network presentations, document camera compatibility and optional wireless connectivity

**Advanced networking features** — EasyMP<sup>®</sup> for remote monitoring/control; message broadcasting; seamless integration with Crestron RoomView, without an A/V control box



## Leading-edge technology

### HDMI input for high-quality, high-definition video

- Deliver both audio and brilliant HD video content with just one cable
- Compatible with the latest laptops, Blu-ray® and media players



### PC-free presentations

- Just plug your USB memory device into the USB port, and you are ready to display whichever slide you choose from the drive
- Compatible with the following file formats: JPG/BMP/GIF/PNG/FSE/SIT
- Create a slideshow using files on the USB drive

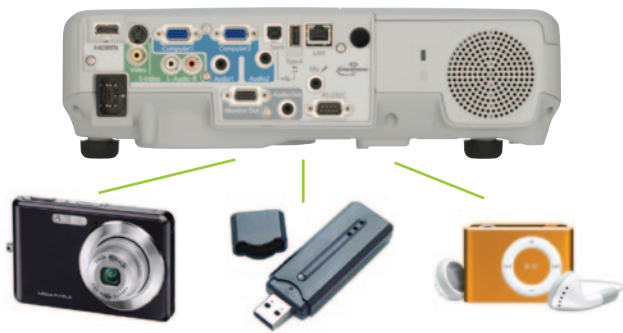

### Wireless connectivity

The optional wireless LAN module allows you to connect to a wireless infrastructure and make a presentation or monitor/control your projector over the wireless network.

You can also use the Quick Connect Wireless USB Key to set up an adhoc (peer-to-peer) wireless connection with a PC and make presentations from your computer, wirelessly.



### USB Plug 'n Play 3-in-1

- Three features, all with one connection — display your presentation, transmit audio, and use your remote control as a mouse to control your presentation
- No more computer function keys or bulky VGA and audio cables
- Just plug in a standard USB cable and instantly project — compatible with Windows® and Mac®

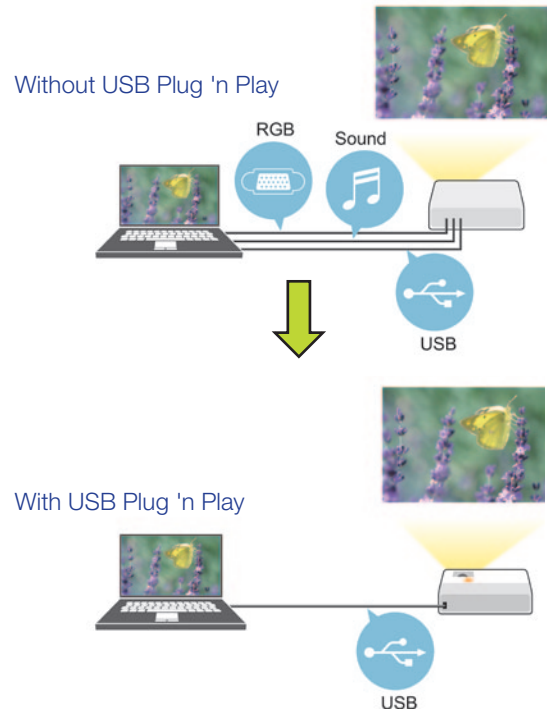

### Document camera

Partner your projector directly with Epson's DC-06 document camera and make more effective presentations to enhance the overall teaching experience.



## Flexible setup

### Horizontal keystone adjustment

- +/- 30 degrees — for the ultimate flexibility when the projector is placed off center; the presenter can stand in front of the screen without blocking the image
- Present from a u-shaped tabletop, without moving the table or putting a stand in the center

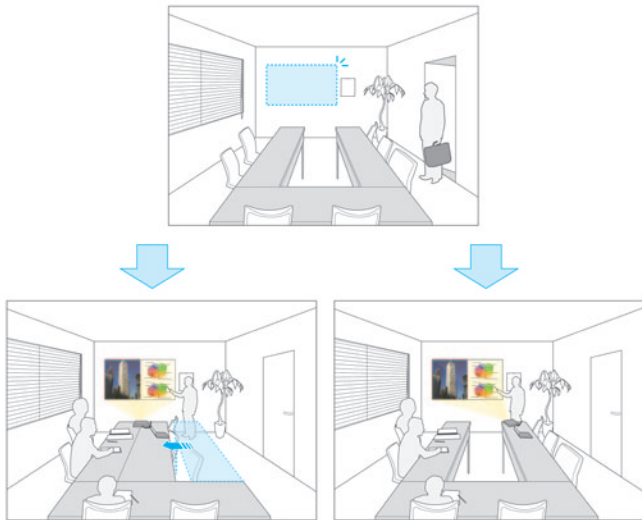

Without Horizontal Keystone      With Horizontal Keystone

### Quick Corner

This innovative feature allows you to move any of the four corners of an image independently at setup, using the remote control to adjust each corner for a perfectly rectangular picture.

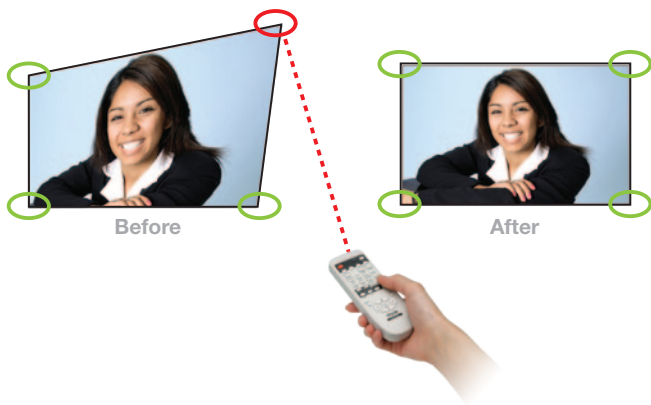

## More visible with higher tilt

- With up to 16 degrees tilt angle, the PowerLite 1835 can project images higher up on the screen or wall, even from a low stand or table, ensuring the whole audience, including those in the back, can get a full view

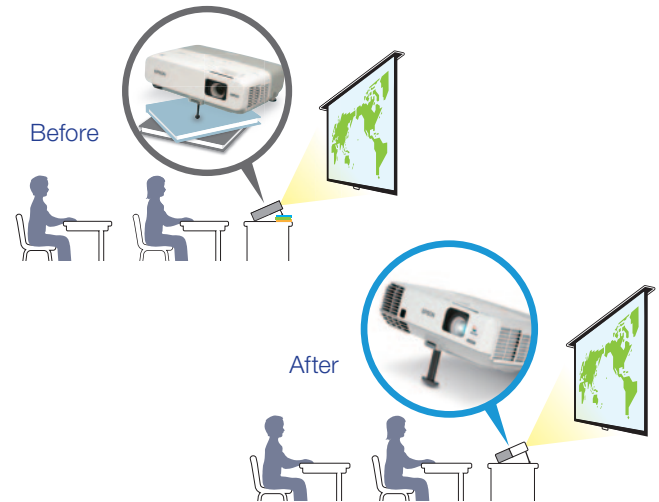

## 1.6x optical zoom

- Equipped with a 1.6x optical zoom, the projector enables you to enlarge images 40% more than with competitive models that use a 1.2x optical zoom
  - Since the zoom is achieved through optical lenses, image quality is not negatively affected
  - A higher zoom means you don't need to position the projector far away from the screen, creating dead space between the screen and the projector

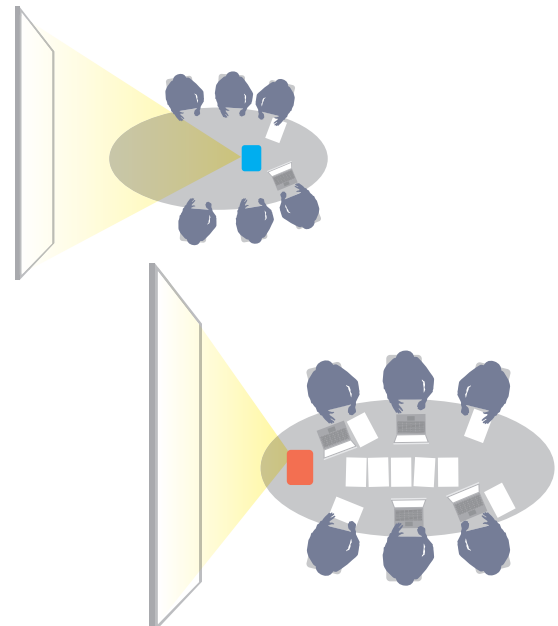

# PowerLite® 1835 MULTIMEDIA PROJECTOR

## The best-selling projectors in the world.

Epson offers a wide range of high-quality projectors to meet most any need. Built with image quality and reliability in mind, Epson projectors enhance communication and inspire collaboration, while offering a low total cost of ownership. From ultraportable projectors designed for educational settings to boardroom-ready business projectors, Epson has the model made for you.



### 3LCD technology — for quality and color that's beyond amazing

- 3 chips for full-time, vibrant color
- 25% less electricity required per lumen of brightness when compared to 1-chip DLP projectors<sup>2</sup>
- Over 20 years of road-tested reliability built into every projector

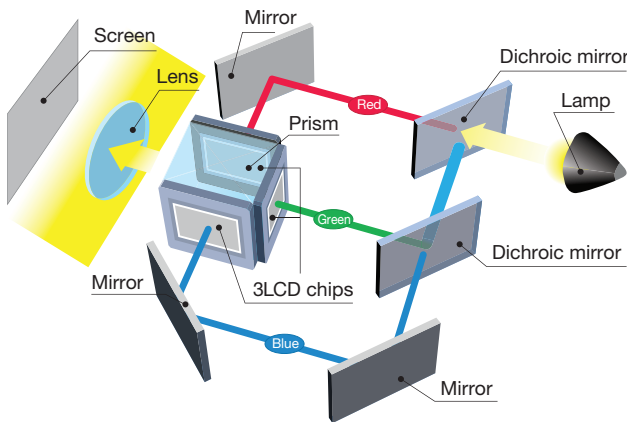

▲ 3LCD, 3-chip technology

### Energy-efficient E-TORL® lamp, exclusively from Epson

- Delivers more lumens per watt and lasts up to 6000 hours<sup>3</sup>
- Minimizes both light diffraction and light leakage
- E-TORL lamps maximize your presentation time, while minimizing your costs

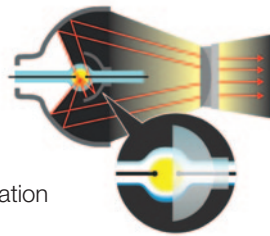

▲ E-TORL lamp

### Amazing color and white light output

Rich color and detail are critical for presentations — that's why it's important to understand that color light output is an essential ingredient in achieving optimum performance. The PowerLite 1835 delivers 3500 lumens of color light output and 3500 lumens of white light output<sup>1</sup> for bright, vibrant, colorful images.



High color light output

Low color light output

Actual photographs of images taken from two competing projectors run in default mode. Price, resolution and brightness (white light output) are the same for both projectors.

### Long-lasting lamp and filter life

- Easy-to-replace lamp and filter
- Lamp replacement cycle of 5000/6000 hours<sup>3</sup> (Normal/Eco Mode)
- Filter maintenance cycle of 5000 hours<sup>4</sup>



### Better Products for a Better Future™

For more information on Epson's environmental programs, go to [eco.epson.com](http://eco.epson.com)

#### Eco Features

- Energy-efficient 3LCD light engine
- Energy-efficient E-TORL lamp
- Low power consumption of 0.3 W in Standby Mode (network communication off)
- Designed to be recycled<sup>5</sup>
- RoHS compliant
- Epson America, Inc. is a SmartWay<sup>SM</sup> Transport Partner<sup>6</sup>



## Advanced networking and more

### Monitor and control

Easily monitor/control up to 1024 networked Epson projectors using the RJ-45 connector and included EasyMP software

- Schedule remote power on/off functionality; saves energy, money and time
- Check the status of each projector as part of your maintenance routine
- Access maintenance alerts for connected projectors, right from your office
- Crestron RoomView enabled — monitor and control your projector with RoomView software, without the need for an A/V control box



### Network presentations

- Present in up to four classrooms from one networked location
- Ideal for distance learning applications
- Use for multi-display configurations to create a panoramic image
- Also works wirelessly with the optional Wireless LAN Module

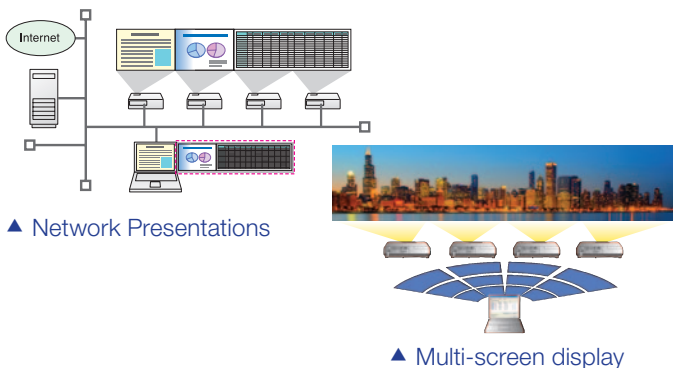

▲ Network Presentations

▲ Multi-screen display

### Message broadcasting

Broadcasts customized and scheduled alerts/messages over the network for announcements or instructions

- Sends messages to up to 1024 projectors at the same time
- Sends ordinary messages as JPEG files, so you can create slides/charts/images
- Create a slideshow by using multiple files within a folder



### Built-in 16 W speaker and microphone input

- Engage your students with 16 W of sound — enable all students in the room to hear your lessons, without purchasing costly speakers or straining the professor's voice
- Works with wired or wireless dynamic or condenser microphones
- Adjust the volume using the projector remote control

### Added features

- Instant Off® — no cool-down time required, so it's ready to shut down when you are
- A/V Mute Slide — control your presentation; it's right at your fingertips
- Sleep Mode — set from 1 to 30 minutes to save energy when the A/V Mute Slide is closed or no signal is detected
- Direct Power On/Off — power the projector on and off with the flip of a wall switch

### Built-in closed captioning



- Essential for education — helps meet ADA508 requirements for students with hearing impairments
- Helps save money — no need to pay for an additional decoder and its installation
- Effective and easy to use — easily enabled or disabled through the projector remote or menu



>>>Phase one projected to be early.

# PowerLite<sup>®</sup> 1835

## Multimedia Projector

Product Name	Product Code	UPC
PowerLite 1835	V11H389020	0 10343 88050 4
Genuine Epson Lamp	V13H010L61	0 10343 88052 8
Replacement Air Filter	V13H134A29	0 10343 88051 1

### Specifications

**Projection System**  
Epson 3LCD, 3-chip technology

**Projection Method**  
Front/rear/ceiling mount

**Driving Method**  
Epson Poly-silicon TFT Active Matrix

**Pixel Number**  
786,432 pixel x 3 LCDs (1024 x 768)

**Native Resolution**  
1024 x 768 (XGA)

**Aspect Ratio**  
4:3

**Color Light Output<sup>1</sup>**  
3500 Lumens

**White Light Output<sup>1</sup>**  
3500 Lumens (ISO 21118 standard)

**Contrast Ratio**  
**(High Brightness, Dynamic Mode)**  
2000:1

**Brightness Uniformity (typical)**  
89%

**Color Reproduction**  
16.7 million colors

**Size (projected distance)**  
30" – 300"

**Keystone Correction (automatic)**  
Vertical: ± 30 degrees - auto  
Horizontal: ± 30 degrees - manual

**Lamp Type**  
E-TORL 230 W UHE

**Lamp Life<sup>2</sup>**  
4000 hours (Normal Mode)  
6000 hours (ECO Mode)

### Effective Scanning Frequency Range

**Pixel Clock**  
13.5 MHz – 162 MHz (up to UXGA 60 Hz)

**Horizontal**  
15 kHz – 92 kHz

**Vertical**  
50 Hz – 85Hz

### Video I/O

**Display Performance**  
NTSC: 480 line  
PAL: 576 line  
(depends on the observation of the multi-burst pattern)

**Input Signal**  
NTSC/NTSC4.43/PAL/M-PAL/N-PAL/  
PAL60/SECAM  
480i/576i/480p/576p/720p/1080i/1080p

### Interfaces

HDMI x 1  
Computer: D-sub 15pin x 2  
Monitor-out: D-sub 15pin x 1  
Video: RCA x 1  
S-Video x 1  
Network: RJ-45 x 1, 100 Mbps  
Wireless LAN: Optional 802.11 a/b/g  
Serial: RS-232c  
USB: Type-A x 1, Type-B x 1  
Microphone: Mini stereo x 1  
Audio: Mini stereo x 2  
Audio: RCA (L and R)  
Audio out: Mini stereo x 1

### USB Plug 'n Play

Video (1024 x 768)  
Audio  
Mouse and Keyboard  
PC and Mac compatible

### Projection Lens

**Type**  
Powered focus/Manual zoom

**F-number**  
1.51 – 1.99

**Focal Length**  
18.2 mm – 29.2 mm

**Zoom Ratio**  
Optical zoom 1.0 – 1.6

**Throw Ratio Range**  
1.38 – 2.24

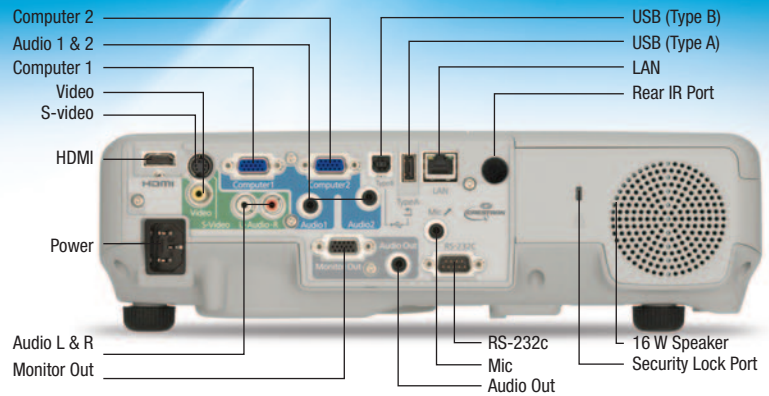

### Other

**Speaker**  
16 W (mono)

**Operating Temperature**  
41 ° to 95 °F (5 ° to 35 °C)

**Power Supply Voltage**  
100 – 240 V ± 10%, 50/60 Hz AC

**Power Consumption**  
355 W (Normal Mode)  
263 W (ECO Mode)  
8.9 W Standby (Communication On)  
0.29 W Standby (Communication Off)

**Fan Noise**  
37 dB (Normal Mode)  
29 dB (ECO Mode)

**Security**  
Security cable hole, Kensington<sup>®</sup> lock provision

**Dimensions (W x D x H)**  
Including feet: 13.58" x 10.35" x 5.17"  
Excluding feet: 13.58" x 10.35" x 3.66"  
Weight: 7.4 lb

### Remote Control

**Features**  
Power, source search selection, computer, video, A/V mute, freeze, user, ID num, auto, aspect, color mode, page up and down, E-zoom, volume, help, menu, enter, esc and pointer functions

**Operating Angle**  
Right/left:  
Front: ± 60 degrees  
Rear: ± 30 degrees  
Upper/lower:  
Front: ± 30 degrees  
Rear: ± 30 degrees

**Operating Distance**  
19.6 ft

### Support

**The Epson Connection<sup>SM</sup>**  
Pre-sales support  
U.S. and Canada 800-463-7766  
Internet website [www.epson.com](http://www.epson.com)

**Service Programs**  
Two-year limited warranty, Epson Road Service program, Epson PrivateLine<sup>®</sup> dedicated toll-free support (U.S. and Canada only) and 90-day limited lamp warranty

**What's In The Box**  
PowerLite 1835 projector, power cable, computer cable (VGA), projector remote control with batteries, user manual CD, EasyMP software CD, password protection sticker

### Accessory Part Numbers

Genuine Epson lamp	V13H010L61
Air filter set	V13H134A29
Soft carrying case	V12H001K64
50" portable roll screen	ELPSC06
60" portable roll screen (4:3)	ELPSC27
80" portable roll screen (4:3)	ELPSC28
100" roll screen (4:3)	ELPSC29
53" magnet type screen (4:3)	ELPSC30
64" magnet type screen (4:3)	ELPSC31
70" magnet type screen (16:10)	ELPSC23
80" magnet type screen (16:10)	ELPSC24
90" magnet type screen (16:10)	ELPSC25
6' Computer cable	ELPKC02
10' Computer cable	ELPKC09
65' Computer cable	ELPKC10
Component video cable	ELPKC19
HD-TV cable	ELPKC22
Ceiling mount	ELPMB23
Pipe 450 mm	ELFPF13
Pipe 700 mm	ELFPF14
Wireless LAN module	V12H418P12
Quick Connect Wireless USB key	V12H005M08
USB document camera	V12H321001
Ceiling mount speaker AP-60	V12H329020
Wireless mic unit	ELPMC01
DC-06 document camera	V12H377020
Interactive unit (wall type)	V12H415020

### Packaging Specifications

**PowerLite 1835**  
Dimensions 14.1" x 19.1" x 6.7" (W x D x H)  
Weight 11.33 lb

**Genuine Epson Lamp**  
Dimensions 6.3" x 5.6" x 5.6" (W x D x H)  
Weight 0.7 lb

**Master Carton**  
Dimensions 28.4" x 13.1" x 6.8" (W x D x H)  
Weight 9.5 lb

Units Per Master Carton 10

**Replacement Air Filter**  
Dimensions 4.9" x 3.9" x 1.2" (W x D x H)  
Weight 0.1 lb

**Master Carton**  
Dimensions 12.7" x 5.2" x 4.6" (W x D x H)  
Weight 1.1 lb

Units Per Master Carton 10

1 White and color light output will vary depending on mode selected. White light output measured using ISO 21118 standard.

2 Data source: ProjectorCentral.com, Jan. 2010. Average of 910 shipping models for which the manufacturers provided lumens and total power data, all resolutions and brightness levels.

3 Lamp life will vary depending upon mode selected, environmental conditions and usage. Lamp brightness decreases over time.

4 Recommendation based on normal room conditions. Cleaning requirements may vary depending on use, environment and other conditions. Cleaning intervals may be adjusted to accommodate the environment in which the projector is used.

5 See our website for convenient and reasonable recycling options at [www.epson.com/recycle](http://www.epson.com/recycle)

6 SmartWay is an innovative partnership of the U.S. Environmental Protection Agency that reduces greenhouse gases and other air pollutants and improves fuel efficiency.

**Epson America, Inc.**  
3840 Kilroy Airport Way, Long Beach, CA 90806

**Epson Canada, Ltd.**  
3771 Victoria Park Avenue, Toronto, Ontario M1W 3Z5

[www.epson.com](http://www.epson.com)  
[www.epson.ca](http://www.epson.ca)

Specifications and terms are subject to change without notice. Epson, EasyMP, E-TORL, Instant Off and Quick Corner are registered trademarks, Epson Exceed Your Vision is a registered logomark and Better Products for a Better Future is a trademark of Seiko Epson Corporation. PowerLite and PrivateLine are registered trademarks and Epson Connection is a service mark of Epson America, Inc. SmartWay is a service mark of the U.S. Environmental Protection Agency. All other product and brand names are trademarks and/or registered trademarks of their respective companies. Epson disclaims any and all rights in these marks. Copyright 2011 Epson America, Inc. 2/11 CPD-33510