

BenQ

W500 LCD Projector

Home Entertainment Series

User Manual

Welcome

Table of contents

Important safety instructions	5
Introduction	8
Projector features	8
Shipping contents	9
Standard accessories	9
Optional accessories	9
Projector exterior view	10
Front and upper side	10
Rear side	10
Under side	10
Controls and functions	11
Projector	11
Remote control	12
Replacing the remote control batteries	13
Remote control effective range	13
Positioning your projector	14
Choosing a location	14
Obtaining a preferred projected picture size	15
How to determine the position of the projector for a given screen size	15
How to determine the recommended screen size for a given distance	15
Installation for a 16:9 ratio screen	16
Installation for a 4:3 ratio screen	17
Shifting the projection lens	18
Connection	19
Connecting a computer	19
Connecting Video source devices	20
Connecting a HDMI device	20
Connecting a Component-Video source device	21
Connecting an S-video or a composite Video source device	22
Using the projector	23
Start up	23
Utilizing the password function	24
Setting a password	24
If you forget the password	24
Entering the password recall procedure	24
Changing the password	25
Disabling the password function	25
Switching input signal	25
Activating automatic source search	25

Speeding up the process of source search	26
Adjusting the projected image	26
Adjusting the projection angle	26
Fine-tuning the image size and clarity	26
Correcting two-dimensional keystone	26
Correcting pincushion and barrel distortion	27
Optimizing the image	28
1. Selecting a picture mode	28
2. Adjusting picture quality	29
3. Selecting the aspect ratio	29
Advanced picture quality controls	30
Setting black level	30
Adjusting picture clarity	31
Selecting a color temperature	31
Setting a preferred color temperature	31
Color management	32
Activating the blue filter	32
Operating in a high altitude environment	33
Searching for details on the projected image	33
Creating your own startup screen	33
Personalizing the projector menu display	34
Turning the power off	34
Menus	35
On Screen Display (OSD) structure	35
Using the menus	36
Picture--Basic menu	37
Picture--Advanced menu	38
Display menu	38
System Setup menu	39
Advanced Setup menu	40
Information menu	41
Maintenance	42
Care of the projector	42
Cleaning the lens	42
Storing the projector	42
Transporting the projector	42
Cleaning and replacing the dust filter	42
Lamp Information	44
Calculation of lamp hour	44
Replacing the lamp	45
Temperature information	47

Indicators	47
Troubleshooting	49
Specifications	50
Projector specifications	50
Optical	50
Electrical	50
Terminals	50
General characteristics	50
Dimensions	50
Timing chart	51
Warranty and Copyright information	53
Copyright	53
Disclaimer	53
Warranty	53
Regulation statements	54
FCC statement	54
EEC statement	54
MIC statement	54
WEEE directive	54

1 Important safety instructions

Your BenQ projector is designed and tested to meet the latest standards for safety of information technology equipment. However, to ensure safe use of this product, it is important that you follow the instructions mentioned in this manual and marked on the product.

Safety instructions

1. Please read this user manual before you operate your projector. Keep this manual in a safe place for future reference.

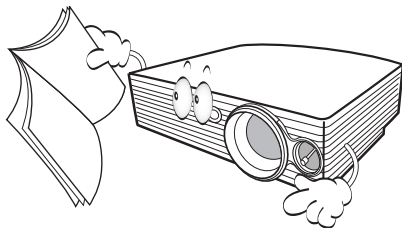

2. Always place the projector on a level, horizontal surface during operation.
 - Do not place the projector on an unstable cart, stand, or table as it may fall and be damaged;

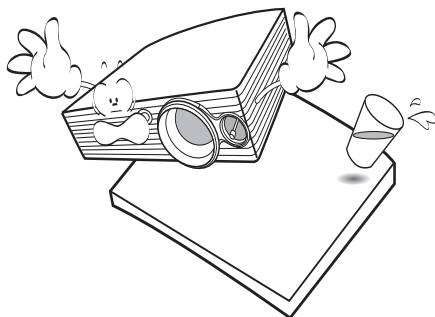

- Do not place inflammables near the projector;
- Do not use if tilted at an angle of more than 10 degrees left to right, nor at angle of more than 15 degrees front to back.

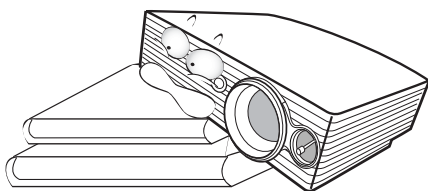

3. When you think service or repair is required, take the projector only to a suitably qualified technician.

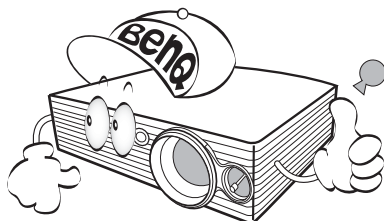

4. Do not place the projector in any of the following environments:
 - space that is poorly ventilated or confined. Allow at least 50 cm clearance from walls and free flow of air around the projector;
 - locations where temperatures may become excessively high, such as the inside of a car with all windows closed;
 - locations where excessive humidity, dust, or cigarette smoke may contaminate optical components, shortening the projector's lifespan and darkening the screen;

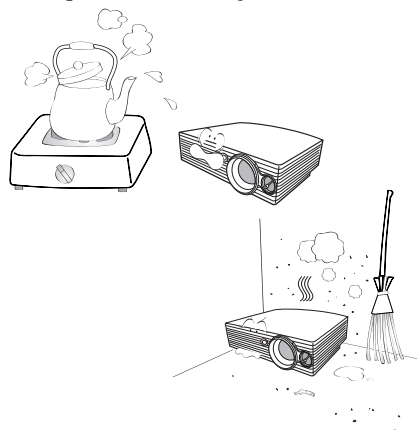

- locations near fire alarms;
- locations with an ambient temperature above 40°C / 104°F;
- locations where altitude is higher than 3050 metres / 10000 feet above sea level.

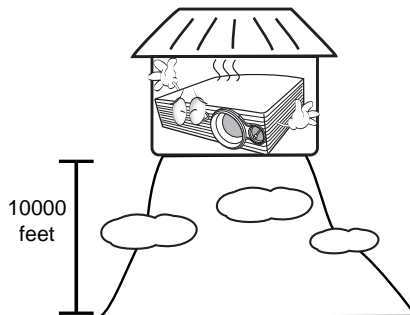

Safety instructions (continued)

5. Do not block the ventilation holes whilst the projector is on (even in standby mode):
- Do not cover the projector with any item;
 - Do not place the projector on a blanket, bedding or any other soft surface.

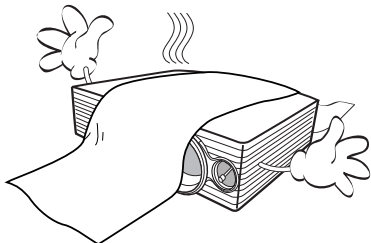

6. In areas where the mains power supply voltage may fluctuate by ± 10 volts, it is recommended that you connect your projector through a power stabilizer, surge protector or uninterruptible power supply (UPS) as appropriate to your situation.

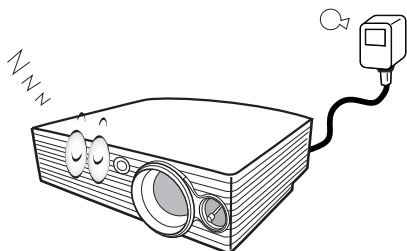

7. Do not step on the projector or place any objects upon it.



8. Do not place liquids near or on the projector. Liquids spilled into the projector will void your warranty. If the projector does become wet, disconnect it from the power point and call BenQ to have the projector repaired.

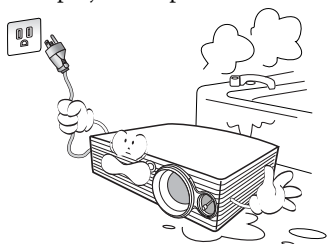

9. Do not look straight into the projector lens during operation. It may harm your sight.

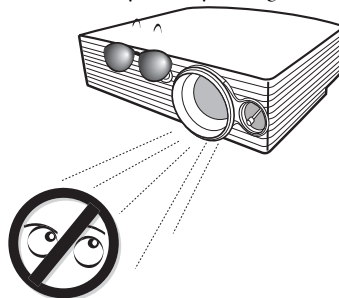

10. Do not operate the projector lamp beyond the rated lamp life. Excessive operation of lamps beyond the rated life could cause a lamp to break on rare occasions.

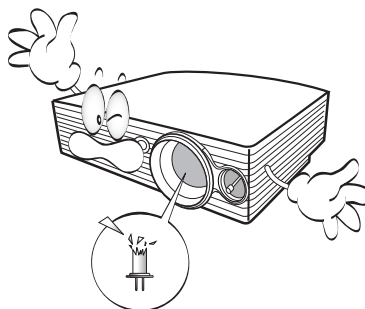

11. The lamp becomes extremely hot during operation. Allow the projector to cool for approximately 45 minutes prior to removing the lamp assembly for replacement.

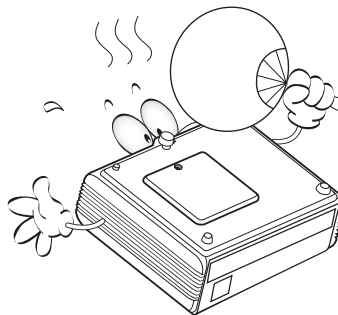

Safety instructions (continued)

12. Never attempt to replace the lamp assembly until the projector has cooled down and is unplugged from the power supply.
15. This projector is capable of displaying inverted images for ceiling mount installation. Use only BenQ's Ceiling Mounting Kit for mounting.

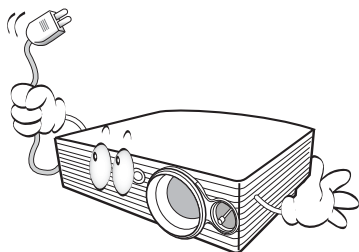

13. Do not attempt to disassemble this projector. There are dangerous high voltages inside which may cause death if you should come into contact with live parts. The only user serviceable parts are the lamp and air filters which have their own removable covers or access panels. See page 42. Under no circumstances should you ever undo or remove any other covers. Refer servicing only to suitably qualified professional service personnel.

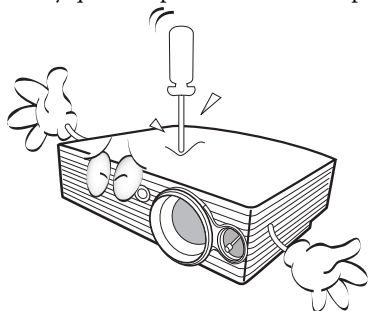

14. Do not store the projector on end vertically. Doing so may cause the projector to fall over, causing injury or resulting in damage.

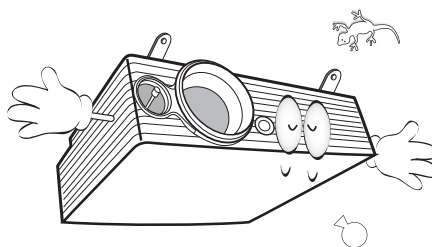
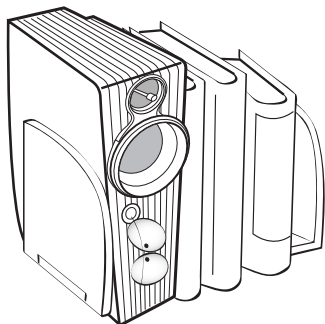

⚠ Ceiling mounting the projector

We want you to have a pleasant experience using your BenQ projector, so we need to bring this safety matter to your attention to prevent possible damage to person and property.

If you intend to mount your projector on the ceiling, we strongly recommend that you use a proper fitting BenQ projector ceiling mount kit and that you ensure it is securely and safely installed.

If you use a non-BenQ brand projector ceiling mount kit, there is a safety risk that the projector may fall from the ceiling due to an improper attachment through the use of the wrong gauge or length screws.

You can purchase a BenQ projector ceiling mount kit from the place you purchased your BenQ projector. BenQ recommends that you also purchase a separate Kensington lock compatible security cable and attach it securely to both the Kensington lock slot on the projector and the base of the ceiling mount bracket. This will perform the secondary role of restraining the projector should its attachment to the mounting bracket become loose.

2 Introduction

Projector features

The projector integrates high-performance optical engine projection and a user-friendly design to deliver high reliability and ease of use.

The projector offers the following features.

- Three-panel LCD system to deliver superior brightness, color saturation and color depth
 - HQV (Hollywood Quality Video) scaler functionality to provide excellent picture quality employing contrast and clarity enhancement, noise reduction and motion optimization
 - Intuitive control over the lens shift lever to provide flexibility in setting-up your projector
 - Unique cooling system design to prevent unnecessary fan noise, rated at less than 32dB in Economic mode
 - Selectable password protected function
 - High quality manual zoom lens
 - Two-way digital keystone correction, pincushion and barrel corrections to correct distorted images
 - Ultra-high brightness projection lamp
 - Multi-language On-Screen Display (OSD) menus
 - Switchable normal and Economic modes to reduce the power consumption
 - Powerful AV function to provide high quality video image
 - Dynamic iris system to achieve a high contrast ratio of 5000:1
 - Component HDTV compatibility
 - A wide variety of inputs for connection to your video and PC equipment
-  • **The apparent brightness of the projected image will vary depending on the ambient lighting conditions, selected input source contrast/brightness settings, and is directly proportional to projection distance.**
- **The lamp brightness will decline over time and may vary within the lamp manufacturers specifications. This is normal and expected behavior.**

Shipping contents

The projector is shipped with the cables required for connection to a video and PC equipment. Some of the items may not be available depending on your region of purchase. Please check with your place of purchase.

Standard accessories

 Some of the accessories may vary from region to region, and may differ from those illustrated.

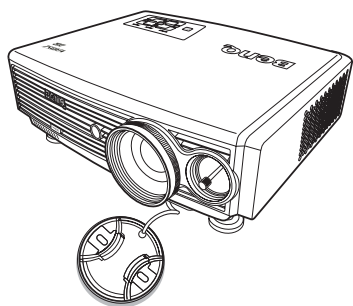

Projector



Remote control and two
AAA batteries



User manual



Quick start guide



User manual CD



Warranty card



Safety manual

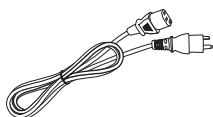

Power cable

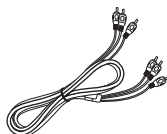

Component Video cable

Optional accessories

1. HDMI Cable
2. Spare lamp kit
3. Ceiling mount kit

Projector exterior view

Front and upper side

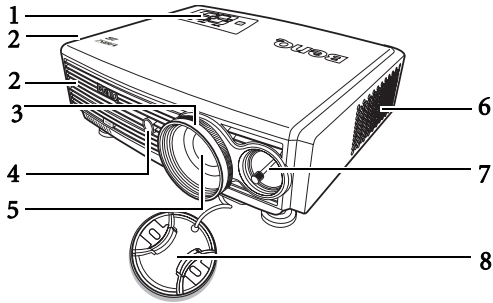

1. External control panel (See page 11 for details)
2. Vent (heated air exhaust)
3. Focus and Zoom adjustment
4. Front IR sensor
5. Projection lens
6. Inlet (cool air intake)
7. Len shift lever
8. Lens cap

Rear side

See "Connection" on page 19 for connection details.

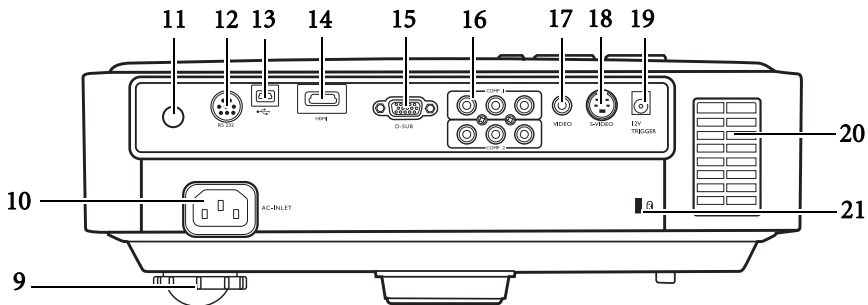

9. Front Adjuster foot
10. AC power cord inlet
11. Rear IR sensor
12. RS-232C port
13. USB socket
14. HDMI port
15. RGB socket
16. Component Video inputs (RCA)
Support Y/PB/PR or Y/CB/CR video signal
17. Composite Video input (RCA)
18. S-Video input (mini 4-pin DIN)
19. 12VDC output terminal
Used to trigger external devices such as an electric screen or lighting controls, etc. Consult your dealer for how to connect to these devices.
- ⚠ Note that the total maximum current must not exceed 0.5 A.
20. Inlet (cool air intake)
21. Kensington anti-theft lock slot

Under side

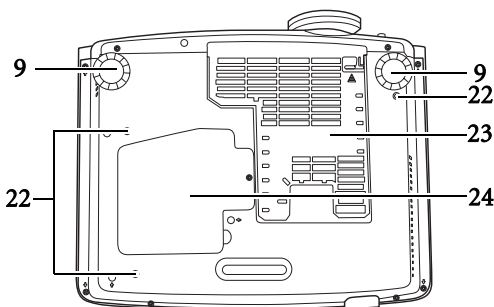

22. Ceiling mounting bracket screw holes
23. Dust filter grill
24. Lamp cover

Controls and functions

Projector

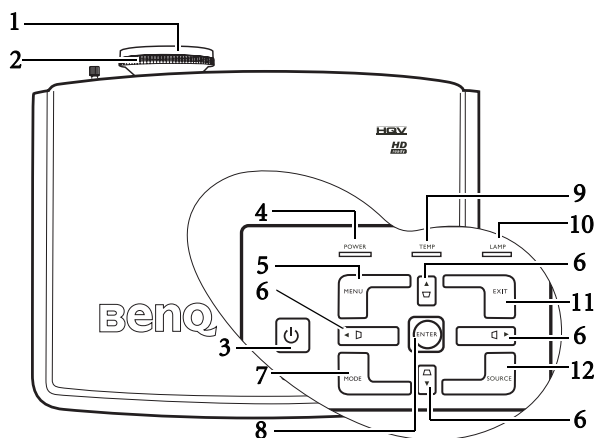

1. **Focus ring**
Adjusts the focus of the projected image. See "[Fine-tuning the image size and clarity](#)" on page 26 for details.
2. **Zoom ring**
Adjusts the size of the image. See "[Fine-tuning the image size and clarity](#)" on page 26 for details.
3. **POWER**
Turns the projector on or off. See [pages 23, 34 and 47](#) for details.
4. **POWER indicator light**
Lights up or flashes when the projector is operating. See "[Temperature information](#)" on page 47 for details.
5. **MENU**
Toggles the On-Screen Display (OSD) menu on and off. See "[Using the menus](#)" on page 36 for details.
6. **Keystone /Arrows buttons (◀Left, ▲Up, ▶Right, ▼Down)**
Manually corrects distorted images resulting from an angled projection. See "[Correcting two-dimensional keystone](#)" on page 26 for details. When the On-Screen Display (OSD) menu is activated, the buttons are used as directional arrows to select the desired menu items and to make adjustments. See "[Using the menus](#)" on page 36 for details.
7. **MODE**
Sequentially selects a predefined picture setting available for each input. See "[1. Selecting a picture mode](#)" on page 28 for details.
8. **ENTER**
Enacts the selected On-Screen Display (OSD) menu item. See "[Using the menus](#)" on page 36 for details.
9. **TEMPerature warning light**
Lights up or flashes if the projector's temperature becomes too high. See "[Temperature information](#)" on page 47 for details.
10. **LAMP indicator light**
Lights up or flashes when the projector lamp has developed a problem. See "[Temperature information](#)" on page 47 for details.
11. **EXIT**
Exits and saves any changes made using the On-Screen Display (OSD) menu. See "[Using the menus](#)" on page 36 for details.
12. **SOURCE**
Sequentially selects the input signal D-SUB, HDMI, Video, S-Video, COMP1 or COMP2. See "[Switching input signal](#)" on page 25 for details.

Remote control

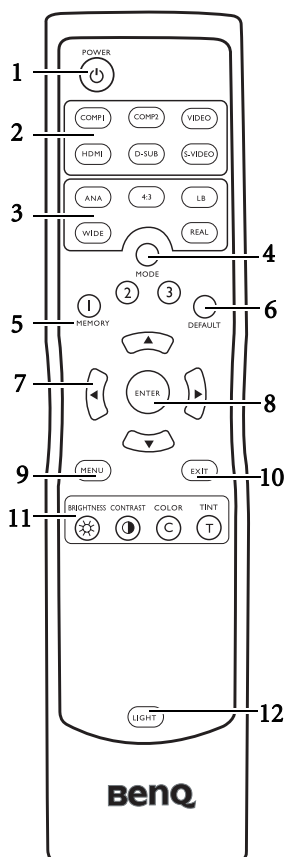

- 1. POWER**
Turns the projector on or off. See [pages 23, 34 and 47](#) for details.
- 2. Source buttons (COMP1, COMP2, VIDEO, HDMI, D-SUB, S-VIDEO)**
Selects an input source for display. See ["Switching input signal" on page 25](#) for details.
- 3. Aspect buttons (ANA (Anamorphic), 4:3, LB (Letterbox), WIDE, REAL)**
Selects the display aspect ratio. See ["3. Selecting the aspect ratio" on page 29](#) for details.
- 4. MODE**
Selects one of the picture modes (Cinema, Dynamic, Standard, Photo, User 1, User 2, User 3). See ["1. Selecting a picture mode" on page 28](#) for details.
- 5. MEMORY (1, 2, and 3)**
Selects User 1, 2 or 3 picture mode. See ["1. Selecting a picture mode" on page 28](#) for details.
- 6. DEFAULT**
Restores the default settings for current picture mode. See ["1. Selecting a picture mode" on page 28](#) for details.
- 7. Arrows buttons (◀Left, ▲Up, ▶Right, ▼Down)**
Moves the current On-Screen Display (OSD) menu selection in the direction of the arrow being pressed. See ["Using the menus" on page 36](#) for details.
- 8. ENTER**
Enacts the selected On-Screen Display (OSD) menu item. See ["Using the menus" on page 36](#) for details.
- 9. MENU**
Toggles the On-Screen Display (OSD) menu on and off. See ["Using the menus" on page 36](#) for details.
- 10. EXIT**
Exits and saves any changes made using the On-Screen Display (OSD) menu. See ["Using the menus" on page 36](#) for details.
- 11. Picture quality adjustment buttons**
See ["Picture--Basic menu" on page 37](#) for details.
- 12. LIGHT**
Turns on the remote control backlight for about 10 seconds. Pressing any other button while the backlight is on keeps the backlight on for a further 10 seconds. Press the Light button again to turn the backlight off.

Replacing the remote control batteries

1. To open the battery cover, turn the remote control over to view its back, push on the finger grip on the cover and slide it down in the direction of the arrow as illustrated. The cover will slide off.

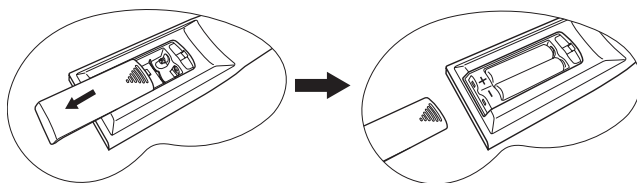

2. Remove any existing batteries (if necessary) and install two new AAA batteries observing the battery polarities as indicated in the base of the battery compartment. Positive (+) goes to positive and negative(-) goes to negative.
3. Refit the cover by aligning it with the case and sliding it back up into position. Stop when it clicks into place.



- **Do not mix old batteries with new ones, or mix different types of batteries.**
- **Avoid leaving the remote control and batteries in an excessive heat or humid environment like the kitchen, bathroom, sauna, sunroom, or in a closed car.**
- **Dispose of used batteries according to the battery manufacturer's instructions and local environment regulations for your region.**
- **If the remote control will not be used for an extended period of time, remove the batteries to avoid damage to the control from possible battery leakage.**

Remote control effective range

Infra-Red (IR) remote control sensors are located on the front and the back of the projector. The remote control must be held at an angle within 45 degrees perpendicular to the projector's IR remote control sensors to function correctly. The distance between the remote control and the sensors should not exceed 8 meters.

Make sure that there are no obstacles between the remote control and the IR sensors on the projector that might obstruct the infra-red beam.

- **Operating the projector from the front**

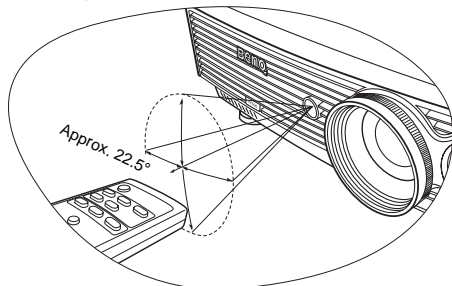

- **Operating the projector from the rear**

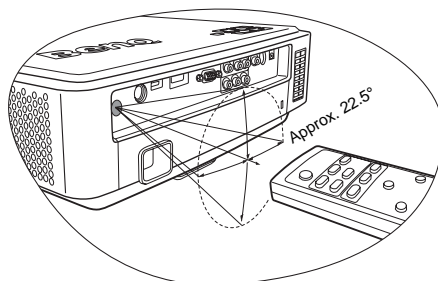

3 Positioning your projector

Choosing a location

Your projector is designed to be installed in one of four possible installation locations:

1. Floor in front of screen;
2. Ceiling in front of screen;
3. Floor at rear of screen; or
4. Ceiling at rear of screen.

Your room layout or personal preference will dictate which installation location you select. Take into consideration the size and position of your screen, the location of a suitable power outlet, as well as the location and distance between the projector and the rest of your equipment.

1. Floor front:

Select this location with the projector placed near the floor in front of the screen. This is the most common way to position the projector for quick setup and portability.

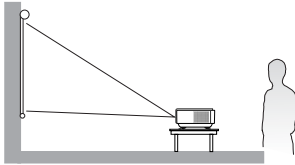

2. Ceiling front:

Select this location with the projector suspended from the ceiling in front of the screen.

Purchase the BenQ Projector Ceiling Mounting Kit from your dealer to mount your projector on the ceiling.

Set **Ceiling Front** in the **System Setup > Projector Position** menu after you turn the projector on.

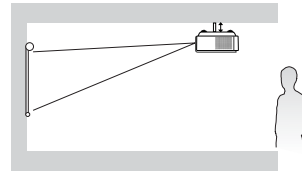

3. Floor rear:

Select this location with the projector placed near the floor behind the screen.

Note that a special rear projection screen is required.

Set **Floor Rear** in the **System Setup > Projector Position** menu after you turn the projector on.

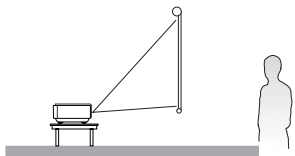

4. Ceiling rear:

Select this location with the projector suspended from the ceiling behind the screen.

Note that a special rear projection screen and the BenQ Projector Ceiling Mounting Kit are required for this installation location.

Set **Ceiling Rear** in the **System Setup > Projector Position** menu after you turn the projector on.

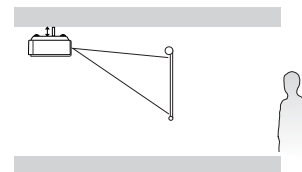

Obtaining a preferred projected picture size

The distance from the projector lens to the screen, the zoom setting, and the video format each factors in the projected image size. BenQ has provided separate tables of dimensions for both 16:9 and 4:3 screen ratios to assist you in determining the ideal location for your projector.

The projector should always be placed horizontally level (like flat on a table), and positioned directly perpendicular (90° right-angle square) to the horizontal center of the screen. This prevents image distortion caused by angled projections (or projecting onto angled surfaces).

If the projector is mounted on a ceiling, it must be mounted upside-down so that it projects at a slightly downward angle.

This projector is equipped with a movable lens. See ["Shifting the projection lens"](#) on page 18 for details.

BenQ has provided tables of 16:9-aspect-ratio and 4:3-aspect-ratio screen sizes to assist you in determining the ideal location for your projector. The vertical offset heights in the dimension tables on page 16 and 17 are measured when the lens is shifted fully up or down. You can see from the diagrams on page 16 and 17, that this type of projection causes the bottom edge of the projected image to be vertically offset from the horizontal plane of the projector. When ceiling mounted, this refers to the top edge of the projected image.

There are two dimensions to consider, the perpendicular horizontal distance from the center of the screen (projection distance), and the vertical offset height of the projector from the horizontal edge of the screen (offset).

If the projector is positioned further away from the screen, the projected image size increases, and the vertical offset also increases proportionately.

When determining the position of the screen and projector, you will need to account for both the projected image size and the vertical offset dimension, which are directly proportional to the projection distance.

How to determine the position of the projector for a given screen size

1. Determine the aspect ratio of your screen, 16:9 or 4:3?
2. Refer to the table and find the closest match to your screen size in the left columns labelled ["Screen Dimensions"](#). Using this value, look across this row to the right to find the corresponding average distance from screen value in the column labelled "Average". This is the projection distance.

For example, if you are using a 120-inch, 4:3-aspect-ratio screen, please refer to ["4:3 \(standard\) ratio screen dimension table"](#). The average projection distance is 5332 mm.

If you place the projector in a different position (to that recommended), you will have to tilt it down or up to center the image on the screen. In these situations, some image distortion will occur. Use the Keystone function to correct the distortion. See ["Adjusting the projected image"](#) on page 26 for details.

How to determine the recommended screen size for a given distance

This method can be used for situations where you have purchased this projector and would like to know what screen size will fit in your room.

The maximum screen size is limited by the physical space available in your room.

1. Determine the aspect ratio of your screen, 16:9 or 4:3?
2. Measure the distance between the projector and where you want to position the screen. This is the projection distance.
3. Refer to the table and find the closest match to your measurement in the average distance from screen column labelled "Average". Check that your measured distance is between the min and max distances listed on either side of the average distance value.
4. Using this value, look across that row to the left to find the corresponding screen diagonal listed in that row. That is the projected image size of the projector at that projection distance.

For example, if you have a 16:9-aspect-ratio screen and your measured projection distance was 4.5m (4500mm), please refer to ["16:9 \(widescreen\) ratio screen dimension table"](#). The closest match in the "Average"

column is 4356 mm. Looking across this row shows that a 3048 mm (30.48 m) screen is required. If you can only obtain imperial sized screens, the screen size is 10' (120") diagonally.

Installation for a 16:9 ratio screen

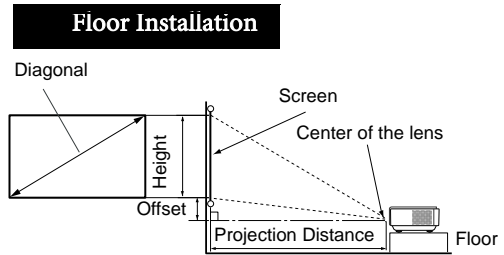
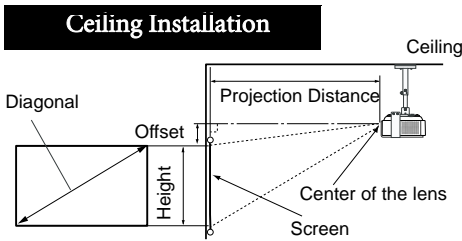

16:9 (widescreen) ratio screen dimension table

Screen Dimensions					Distance from Screen in mm			Vertical Offset in mm	
Diagonal			Width	Height	Min distance (with max. zoom)	Average	Max distance (with min. zoom)	Highest lens position	Lowest lens position
Feet	Inches	mm	mm	mm					
3.3	40	1016	886	498	1320	1452	1584	50	-548
4.2	50	1270	1107	623	1650	1815	1980	62	-685
5.0	60	1524	1328	747	1980	2178	2376	75	-822
5.8	70	1778	1550	872	2310	2541	2772	87	-959
6.7	80	2032	1771	996	2640	2904	3168	100	-1096
7.5	90	2286	1992	1121	2970	3267	3564	112	-1233
8.3	100	2540	2214	1245	3300	3630	3960	125	-1370
9.2	110	2794	2435	1370	3630	3993	4356	137	-1507
10.0	120	3048	2657	1494	3960	4356	4752	149	-1644
10.8	130	3302	2878	1619	4290	4719	5148	162	-1781
11.7	140	3556	3099	1743	4620	5082	5544	174	-1918
12.5	150	3810	3321	1868	4950	5445	5940	187	-2055
13.3	160	4064	3542	1992	5280	5808	6336	199	-2192
14.2	170	4318	3763	2117	5610	6171	6732	212	-2329
15.0	180	4572	3985	2241	5940	6534	7128	224	-2466
15.8	190	4826	4206	2366	6270	6897	7524	237	-2603
16.7	200	5080	4428	2491	6600	7260	7920	249	-2740
20.8	250	1016	5535	3113	8250	9075	9900	311	-3424

Installation for a 4:3 ratio screen

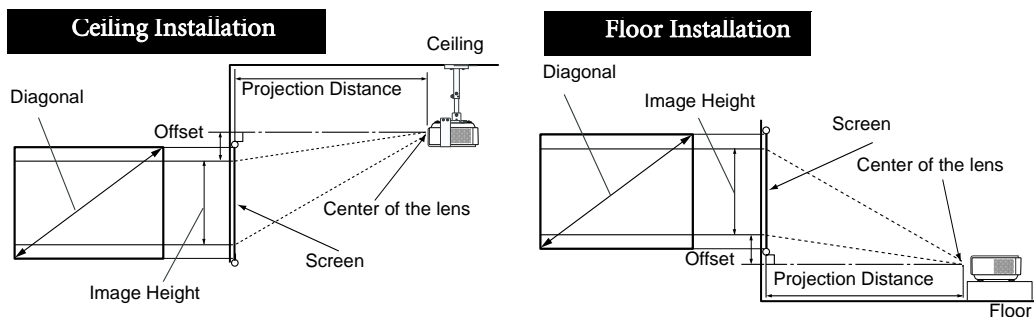

4:3 (standard) ratio screen dimension table

Screen Dimensions					Distance from Screen in mm			Vertical Offset in mm	
Diagonal			Width	Height	Min distance (with max. zoom)	Average	Max distance (with min. zoom)	Highest lens position	Lowest lens position
Feet	Inches	mm	mm	mm					
3.3	40	1016	813	610	1615	1777	1939	61	-671
4.2	50	1270	1016	762	2019	2222	2424	76	-838
5.0	60	1524	1219	914	2423	2666	2909	91	-1006
5.8	70	1778	1422	1067	2827	3110	3394	107	-1173
6.7	80	2032	1626	1219	3230	3554	3878	122	-1341
7.5	90	2286	1829	1372	3634	3999	4363	137	-1509
8.3	100	2540	2032	1524	4038	4443	4848	152	-1676
9.2	110	2794	2235	1676	4442	4887	5333	168	-1844
10.0	120	3048	2438	1829	4846	5332	5818	183	-2012
10.8	130	3302	2642	1981	5249	5776	6302	198	-2179
11.7	140	3556	2845	2134	5653	6220	6787	213	-2347
12.5	150	3810	3048	2286	6057	6665	7272	229	-2515
13.3	160	4064	3251	2438	6461	7109	7757	244	-2682
14.2	170	4318	3454	2591	6865	7553	8242	259	-2850
15.0	180	4572	3658	2743	7268	7997	8726	274	-3018
15.8	190	4826	3861	2896	7672	8442	9211	290	-3185
16.7	200	5080	4064	3048	8076	8886	9696	305	-3353

 There is 3% tolerance among these numbers in the above two tables due to optical component variations. BenQ recommends that if you intend to permanently install the projector, you should physically test the projection size and distance using the actual projector in situ before you permanently install it, so as to make allowance for this projector's optical characteristics. This will help you determine the exact mounting position so that it best suits your installation location.

Shifting the projection lens

The lens shift lever at the front side of the projector provides flexibility for installing your projector. It allows the projector to be positioned off axis from screen center.

The lens shift (offset) is expressed as a percentage of the projected image height or width. It is measured as an offset from the projected image's vertical or horizontal center. The W500 is equipped with $\pm 110\%$ vertical lens shift and $\pm 48.8\%$ horizontal shift. You can use the joystick to shift the projection lens in any direction within the allowable range depending on your desired image position.

- **Vertical lens shift**

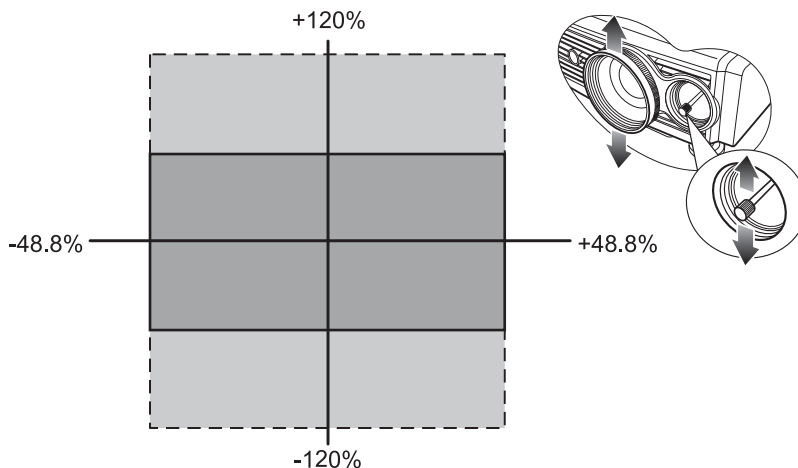

- **Horizontal lens shift**

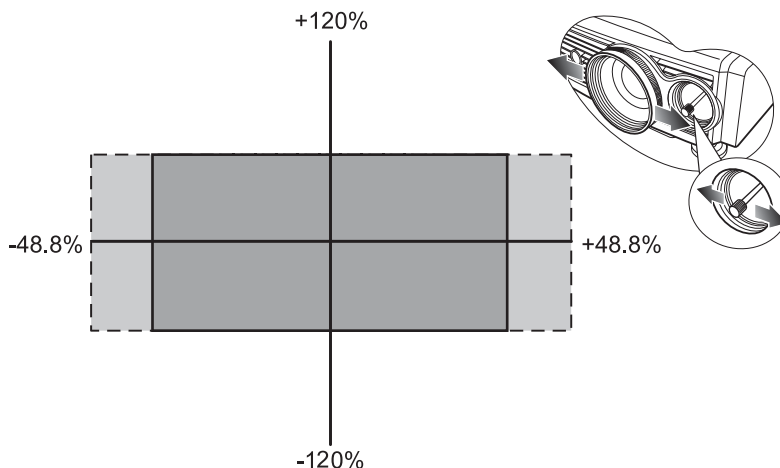

- ☞ • The lens shift lever can be secured by turning it clockwise or released by turning it counterclockwise. Please be careful to not over-tighten it.
- Lens shift adjustment will not result in degraded picture quality. In the unlikely event, image distortion was produced. If so, see "[Adjusting the projected image](#)" on page 26 for details.

4 Connection

You can connect the projector to any type of video equipment, such as a VCR, DVD player, digital tuner, cable or satellite decoder, video game console or digital camera. You can also connect it to a desktop or laptop PC or Apple Macintosh system.

The projector can be connected to multiple video equipment at the same time by using different cables. All you need to do is select the appropriate input for the projector to display.

When connecting a signal source to the projector, be sure to:

1. Turn off all equipment before making any connections.
2. Use only the correct type cables for each source with proper type plugs.
3. Ensure that all cable plugs are firmly fitted to the equipment sockets.

Note that all cables shown in the following connection diagrams may not be supplied with the projector (See page 9 for the shipping contents). Most cables are commercially available from electronics stores. We recommend that you purchase international standard cables for cable connection.

Connecting a computer

The projector provides a VGA and HDMI input sockets that allow you to connect it to a laptop or desktop computer.

To connect the projector to a notebook or desktop computer (either through a VGA cable or a HDMI cable):

<ul style="list-style-type: none"> • With a VGA cable: <ol style="list-style-type: none"> 1. Take a VGA cable and connect one end to the D-Sub output socket of the computer. 2. Connect the other end of the VGA cable to the D-Sub signal input socket on the projector. 	<ul style="list-style-type: none"> • With a HDMI cable: <ol style="list-style-type: none"> 1. Take a HDMI cable and connect one end to the HDMI output socket of the computer. 2. Connect the other end of the HDMI cable to the HDMI signal input socket on the projector.
<ol style="list-style-type: none"> 3. You should also connect the separate audio cable to a suitable audio amplifier. 	

The final connection path should be like that shown in the following diagram:

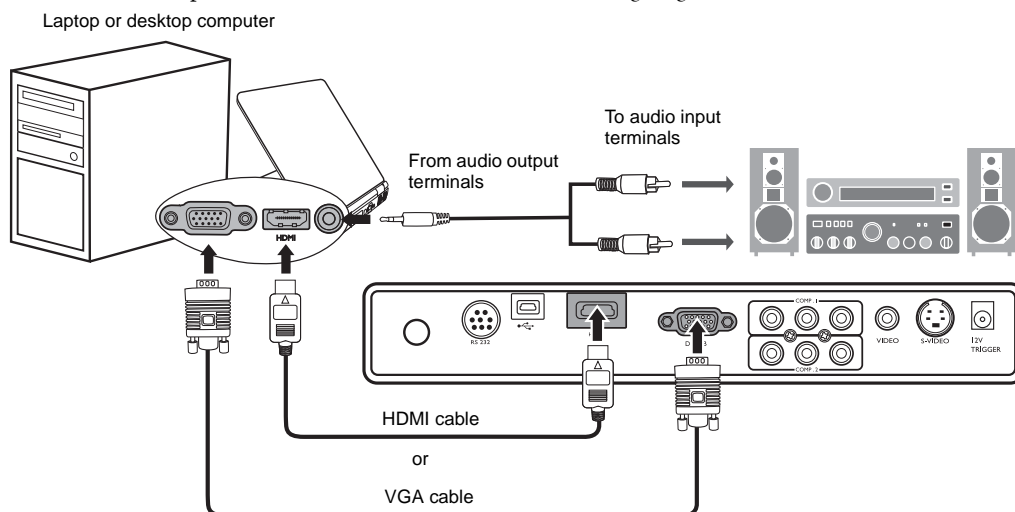

Note Many laptops do not turn on their external video ports when connected to a projector. Usually a key combination like Fn + F3 or CRT/LCD key turns the external display on/off. Locate a function key labeled CRT/LCD or a function key with a monitor symbol on the laptop. Press Fn and the labeled function key simultaneously. Refer to your laptop's documentation to discover your laptop's key combination.

Connecting Video source devices

You can connect your projector to various Video source devices that provide any one of the following output sockets:

- HDMI
- Component Video
- S-Video
- Video (composite)

You need only connect the projector to a Video source device using just one of the above connecting methods, however each provides a different level of video quality. The method you choose will most likely depend upon the availability of matching terminals on both the projector and the Video source device as described below:

Best video quality

The best available video connection method is HDMI. HDMI (High-Definition Multimedia Interface) supports uncompressed video data transmission between compatible devices like DTV tuners, DVD players and displays over a single cable. It provides pure digital viewing and listening experience.

See "[Connecting a HDMI device](#)" on page 20 for how to connect the projector to a HDMI device.

If no HDMI source is available, the next best video signal is Component Video (not to be confused with composite Video). Digital TV tuner and DVD players output Component Video natively, so if available on your devices, this should be your connection method of choice in preference to (composite) Video.

See "[Connecting a Component-Video source device](#)" on page 21 for how to connect the projector to a component video device.

Better video quality

The S-Video method provides a better quality analog video than standard composite Video. If you have both composite Video and S-Video output terminals on your Video source device, you should elect to use the S-Video option.

Least video quality

Composite Video is an analog video and will result in a perfectly acceptable, but less than optimal result from your projector, being the least video quality of the available methods described here.

See "[Connecting an S-video or a composite Video source device](#)" on page 22 for how to connect the projector to an S-Video or composite Video device.

Connecting a HDMI device

Examine your Video source device to determine if it has an unused HDMI socket available:

- If so, you can continue with this procedure.
- If not, you will need to reassess which method you can use to connect to the device.

To connect the projector to a HDMI device:

1. Take a HDMI cable and connect one end to the HDMI output socket of the Video source device.
2. Connect the other end of the HDMI cable to the HDMI input socket on the projector.
3. You should also connect the separate audio cable to a suitable audio amplifier.

The final connection path should be like that shown in the following diagram:

HDMI device: DVD player, digital tuner, etc.

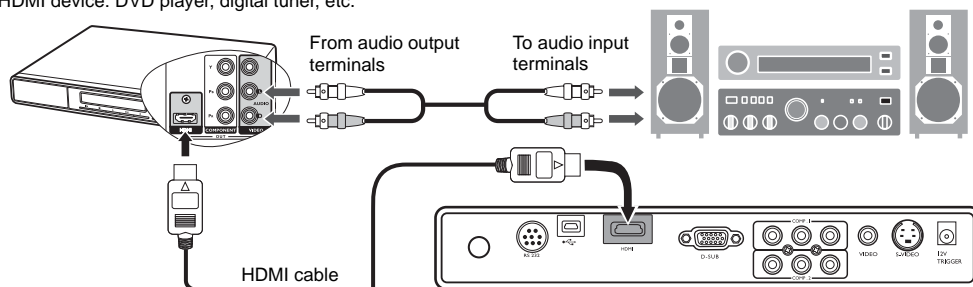

- It is not recommended to establish the connection via a DVI to HDMI cable. The weight of the DVI to HDMI adapter may be pulling down on the HDMI port, causing it to become loose over time.
- If the selected video image is not displayed after the projector is turned on and the correct video source has been selected, please check that the video source device is turned on and operating correctly. Also check that the signal cables have been connected correctly.

Connecting a Component-Video source device

Examine your Video source device to determine if it has a set of unused Component Video output sockets available:

- If so, you can continue with this procedure.
- If not, you will need to reassess which method you can use to connect to the device.

To connect the projector to a Component Video source device:

1. Take a Component Video cable and connect one end to the Component Video output sockets of the Video source device. Match the color of the plugs to the color of the sockets; green to green, blue to blue, and red to red.
2. Connect the other end of the Component Video cable to the COMPONENT sockets on the projector. Match the color of the plugs to the color of the sockets; green to green, blue to blue, and red to red.
3. You should also connect the separate audio cable to a suitable audio amplifier.

The final connection path should be like that shown in the following diagram:

AV equipment: DVD player, digital tuner, etc.

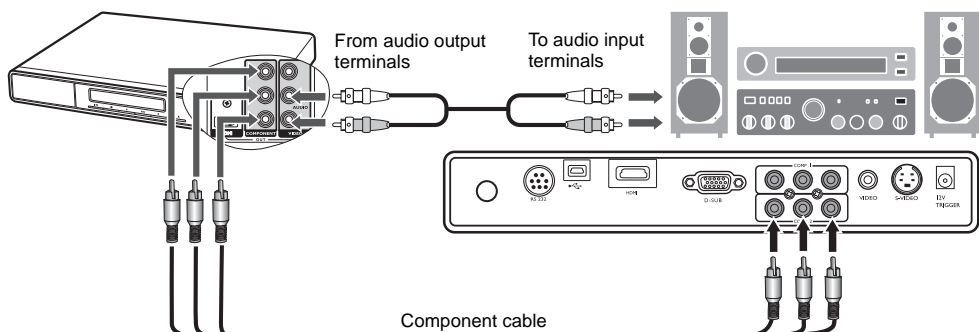

If you connect the projector to a High Definition TV (HDTV) tuner, the following standards are supported:

- 480i
- 576i
- 720p (50/ 60 Hz)
- 1080i (50/ 60 Hz)
- 480p
- 576p
- 1080p (24/ 50/ 60 Hz)

- If the selected video image is not displayed after the projector is turned on and the correct video source has been selected, please check that the video source device is turned on and operating correctly. Also check that the signal cables have been connected correctly.

Connecting an S-video or a composite Video source device

Examine your Video source device to determine if it has an unused S-Video or composite Video output socket available:

- If so, you can continue with this procedure.
- If not, you will need to reassess which method you can use to connect to the device.

If you have already made a Component Video connection between the projector and the video source device, you need not connect to this device again using an S-Video or composite Video connection as this makes an unnecessary second connection of poorer picture quality. You need only connect using a composite Video connection if both Component Video and S-Video are not supplied on the video source device (for example, with some analog video cameras). If S-Video connectivity is available, you should use it in preference to using composite Video.

See "[Connecting Video source devices](#)" on page 20 for details.

To connect the projector to an S-Video or a composite Video source device (either through an S-Video cable or a Video cable):

<ul style="list-style-type: none"> • With an S-Video cable: <ol style="list-style-type: none"> 1. Take an S-Video cable and connect one end to the S-Video output socket of the Video source device. 2. Connect the other end of the S-Video cable to the S-VIDEO socket on the projector. 	<ul style="list-style-type: none"> • With a Video cable: <ol style="list-style-type: none"> 1. Take a Video cable and connect one end to the Video output socket of the Video source device. 2. Connect the other end of the Video cable to the VIDEO socket on the projector.
<ol style="list-style-type: none"> 3. You should also connect the separate audio cable to a suitable audio amplifier. 	

The final connection path should be like that shown in the following diagram:

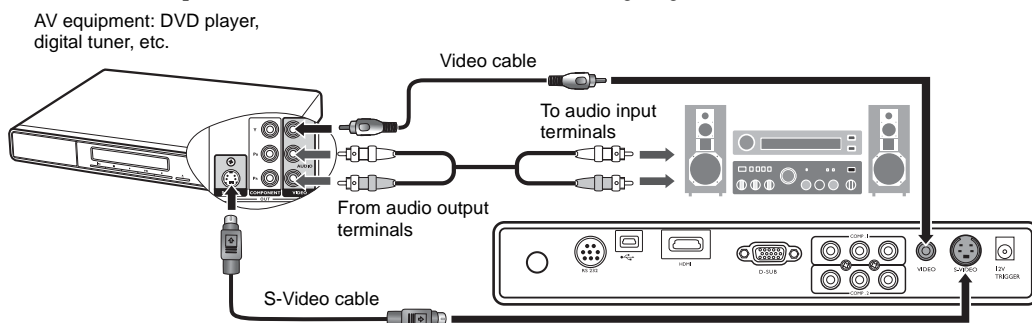

- ☞ **Do not connect both S-Video and composite Video cables from the same video source device at the same time. You should only ever connect one or the other. See "[Connecting Video source devices](#)" on page 20 for details.**
- **If the selected video image is not displayed after the projector is turned on and the correct video source has been selected, please check that the video source device is turned on and operating correctly. Also check that the signal cables have been connected correctly.**

5 Using the projector

Start up

1. Plug the power cord into the projector and into a wall socket. Turn on the wall socket switch (where fitted). Check that the Power indicator on the projector lights orange after power has been applied.

 **The power cable used in the illustration may look different to the power cable type used in your region. Use only the power cable as supplied with the projector, and which is suitable for your region.**

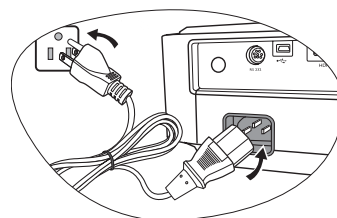

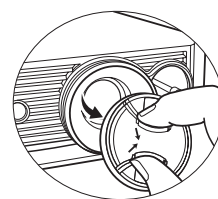

2. Remove the lens cap. If it is left on, it could become deformed due to the heat produced by the projection lamp.

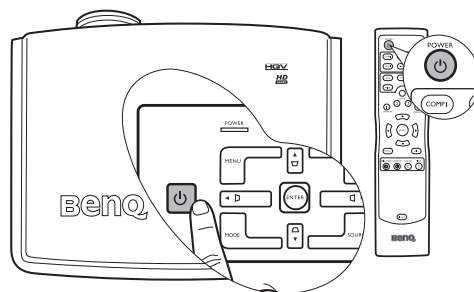

3. Press the  **POWER** on the projector or remote control to turn the projector on. The Power indicator light flashes green and stays green when the projector is on.

The start up procedure takes about 30 seconds. In the later stage of start up, a startup logo is projected. (If necessary) Rotate the focus ring to adjust the image clearness.



 • **The projector will not respond to further commands whilst it is warming up.**

- **If the projector is still hot from previous activity, it will run the cooling fan for approximately 90 seconds before energizing the lamp.**

4. If you are prompted for a password, press the arrow buttons to enter a six digit password. See "[Utilizing the password function](#)" on page 24 for details.

5. Switch on all of the connected equipment.

The projector will start to search for input signals. The current input source being scanned displays in the center of the screen. The searching message will continue displaying until an input source signal is found.

You can press **SOURCE** on the projector or remote control to display the selection bar and switch between different signals. See "[Switching input signal](#)" on page 25 for details.

 **If the frequency/resolution of the input signal exceeds the projector's operating range, you will see the message 'Out of Range' displayed on a blank screen. Please change to an input signal which is compatible with the projector's resolution or set the input signal to a lower setting. See "[Timing chart](#)" on page 51 for details.**

Utilizing the password function

For security purposes and to help prevent unauthorized use, the projector includes an option for setting up password security. The password can be set through the On-Screen Display (OSD) menu. For details of the OSD menu operation, please refer to "Using the menus" on page 36.

⚠ You will be inconvenienced if you activate the password functionality and subsequently forget the password. Print out this manual (if necessary) and write the password you used in this manual, and keep the manual in a safe place for later recall.

Setting a password

👉 Once a password has been set and activated, the projector cannot be used unless the correct password is entered every time the projector is started.

1. Open the OSD menu and go to the **Advanced Setup > Password** menu. Press **ENTER**.
2. Highlight **Password** and select **On** by pressing **◀Left** or **▶Right**.
3. A prompt will display on the screen.
4. As pictured to the right, the four arrow buttons (**▲Up**, **▶Right**, **▼Down**, **◀Left**) respectively represent 4 digits (1, 2, 3, 4). Press the arrow buttons to enter six digits for the password.

Once the password is set, the OSD menu returns to the Password page.



⚠ IMPORTANT: The digits being input will display as asterisks on-screen. Write your selected password down here in this manual in advance or right after the password is entered so that it is available to you should you ever forget it.

Password: _____

Keep this manual in a safe place.

5. Press **EXIT** to go back to the previous page, or press **MENU** to leave the OSD menu.

If you forget the password

If the password function is activated, you will be asked to enter the six digit password every time you turn on the projector. If you enter the wrong password, the password error message as pictured to the right displays lasting for three seconds, and the 'INPUT PASSWORD' message follows. You can retry by entering another six-digit password, or if you did not record the password in this manual, and you absolutely do not remember it, you can use the password recall procedure. See "Entering the password recall procedure" on page 24 for details.

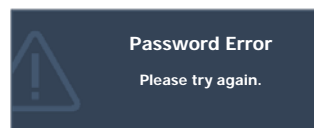

If you enter an incorrect password 5 times in succession, the projector will automatically shut down in a short time.

Entering the password recall procedure

Press **MODE** on the projector or remote control. The projector will display a coded number on the screen. Write down the number and turn off your projector. Seek help from the local BenQ service center to decode the number. You may be required to provide proof of purchase documentation to verify that you are an authorized user of the projector.

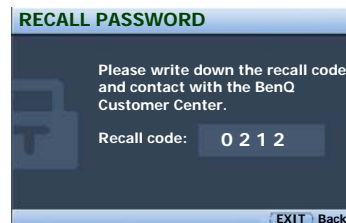

Changing the password

1. Open the OSD menu and go to the **Advanced Setup > Password** menu. Press **ENTER**.
2. Highlight **Change Password**. Press **ENTER**.
3. The message 'INPUT CURRENT PASSWORD' displays. Enter the old password.
 - i. If the password is correct, another message 'INPUT NEW PASSWORD' displays.
 - ii. If the password is incorrect, the password error message displays lasting for three seconds, and the message 'INPUT CURRENT PASSWORD' displays for your retry. You can press **EXIT** to clear and re-enter six digits or go back to the previous page.
4. Enter a new password.

! **IMPORTANT: The digits being input will display as asterisks on-screen. Write your selected password down here in this manual in advance or right after the password is entered so that it is available to you should you ever forget it.**

Password: _ _ _ _ _

Keep this manual in a safe place.

5. Confirm the new password by re-entering the new password.
6. You have successfully assigned a new password to the projector. Remember to enter the new password next time the projector is started.
7. Press **EXIT** to go back to the previous page, or press **MENU** to leave the OSD menu.

Disabling the password function

To disable password protection:

1. Go back to the **Advanced Setup > Password > Password** menu after opening the OSD menu system.
2. Select **Off** by pressing **◀Left** or **▶Right**. The message 'INPUT PASSWORD' displays.
3. Enter the current password.
 - i. If the password is correct, the OSD menu returns to the Password page with '**Off**' shown in the row of Password. You will not have to enter the password next time when turning on the projector.
 - ii. If the password is incorrect, the password error message displays lasting for three seconds, and the message 'INPUT PASSWORD' displays for your retry. You can press **EXIT** to cancel the change or try another password.

☞ **Though the password function is disabled, you need to keep the old password in hand should you ever need to re-activate the password function by entering the old password.**

Switching input signal

The projector can be connected to multiple equipment at the same time. However, it can only display one at a time.

- To select an individual input signal, press one of the Source buttons on the remote control.
- To sequentially cycle through all possible sources, press **SOURCE** on the projector, and the source selection bar displays. Press **▲Up** or **▼Down** repeatedly until your desired signal is selected and press **ENTER**. If there is multiple equipment connected to the projector, you can press the key again to search for another signal.

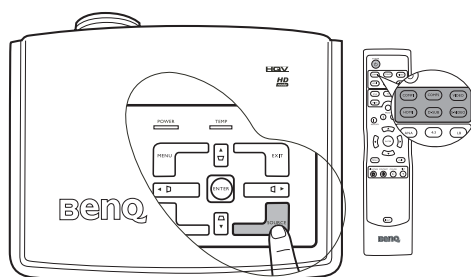

Activating automatic source search

Be sure the **Auto Source Search** in the **System Setup** menu is activated if you want the projector to automatically search the signals. Go to the **System Setup > Auto Source Search** menu and select **On** by pressing **◀Left** or **▶Right**. The projector will scan for input signals until it acquires a signal. If the function is not activated, the projector selects the last used input signal.

Speeding up the process of source search

You can speed up the process of source search by blocking source(s) not in use.

1. Go to the **Advanced Setup > Source Block** menu and press **ENTER**.
2. Highlight the input source with **▲Up** or **▼Down**.
3. Decide whether to **Search** or **Skip** it during input signal detection with **◀Left** or **▶Right**.
4. Repeat Step 2 and 3 until you are satisfied with the settings.
5. Press **EXIT/MENU** to exit and save the settings.

 **Blocking all sources at the same time is not allowed.**

Adjusting the projected image

Adjusting the projection angle

There are two adjuster feet on the bottom of the projector. These can be used if necessary to change the projection angle. Screw the feet in or out as appropriate to aim and level the projection angle.

The lens shift lever adjacent to the projection lens can further assist you in determining the position of the projected image. See "[Shifting the projection lens](#)" on page 18 for details.

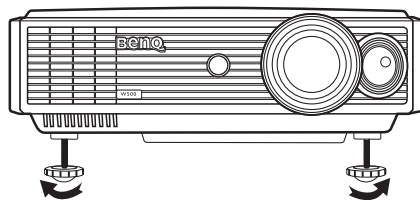

 **If the screen and the projector are not perpendicular to each other, the projected image becomes vertical trapezoidal. To correct this situation, see "[Correcting two-dimensional keystone](#)" on page 26 for details.**

Fine-tuning the image size and clarity

1. Adjust the projected image to the size that you need
2. Then sharpen the image by rotating the focus ring, using the zoom ring.

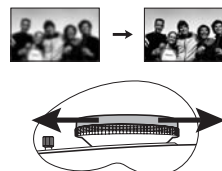
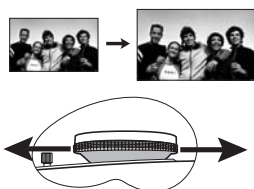

Correcting two-dimensional keystone

Keystoning occurs when the projector is not perpendicular to the screen and is where the projected image displays visible as a trapezoid shape like either of the following:

- Two parallel sides (left and right, or top and bottom) but is noticeably wider on either side.
- No parallel sides.

To correct the image's shape, you can perform the following steps.

1. Adjust the projection angle. Move the projector to be in front of the center of the screen with the base of the lens level with the top or bottom edge of the screen.
2. If the image is still distorted, or the projector is unable to be positioned as described above, you will need to manually correct the image following ONE of these steps.

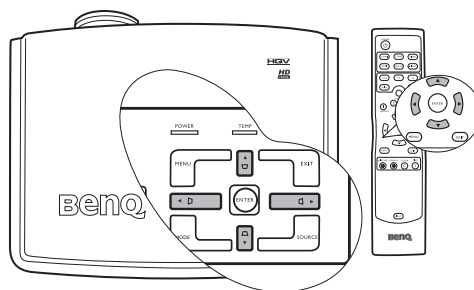

- Press one of the **Keystone/Arrow** buttons (◻ / ▲, ◻ / ◀, ◻ / ▼, ◻ / ▶) on the projector or remote control to display the 2D Keystone correction page. Press the button whose keystone icon is similar to the adjustment you are about to make. For example, the **Up** button (◻ / ▲) will widen the upper side and reduce the bottom side of the picture. Continue pressing the same button or press the other buttons until you are satisfied with the shape.
- Press **MENU** on the projector or remote control. Go to the **Display > Keystone** menu and press **ENTER**. Highlight **2D Keystone** and press **ENTER** to display the Keystone correction page. Press one of the **Keystone/Arrow** buttons (◻ / ▲, ◻ / ◀, ◻ / ▼, ◻ / ▶) on the projector or remote control whose keystone icon is similar to the adjustment you are about to make. Continue pressing the same button or press the other buttons until you are satisfied with the shape.



The values on the lower portion of the page change while pressing. When the values reach their maximum or minimum with repeated button presses, the image's shape will stop changing. You will not be able to change the image further in that direction.

<p>• Two parallel sides (left and right, or top and bottom) but is noticeably wider on either side</p>		
<ul style="list-style-type: none"> • To widen the bottom side, press ◻ / ▼ or • Go to the Display > Keystone menu. Enter the 2D Keystone correction page and press ◻ / ▼ repeatedly until the image's shape becomes square. 		<ul style="list-style-type: none"> • To widen the upper side, press ◻ / ▲ or • Go to the Display > Keystone menu. Enter the 2D Keystone correction page and press ◻ / ▲ repeatedly until the image's shape becomes square.
<p>• No parallel sides</p>		
<ol style="list-style-type: none"> 1. To widen the left side, press ◻ / ◀ or ◻ / ◀. 2. Go to the Display > Keystone menu. Enter the 2D keystone correction page and press ◻ / ◀. 	<ol style="list-style-type: none"> 3. To widen the upper side, press ◻ / ▲ repeatedly until the image is square. 	<ol style="list-style-type: none"> 4. Press EXIT/MENU to exit and save the settings.

Correcting pincushion and barrel distortion

Sometimes, your projected image may suffer from pincushion or barrel distortion due to the curved projection surface.

- **Pincushion distortion**
Horizontal and vertical lines bend inwards toward the center of the picture. The distortion is most noticeable at the four edges of the picture.
- **Barrel distortion**
Horizontal and vertical lines bend outwards toward the edge of the picture. The distortion is most noticeable at the four edges of the picture.

To correct the image's shape, you can perform the following steps.

1. Press **MENU** on the projector or remote control. Go to the **Display > Keystone** menu and highlight **Pincushion Correction**.
2. Press **◀Left** or **▶Right** repeatedly to adjust the image until you are satisfied with the shape.

The values on the adjustment bar of the page change while pressing. When the values reach their maximum or minimum with repeated button presses, the image's shape will stop changing. You will not be able to change the image further in that direction.

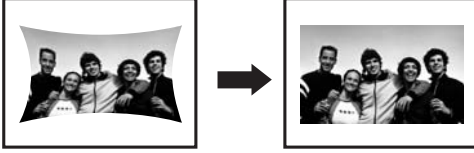
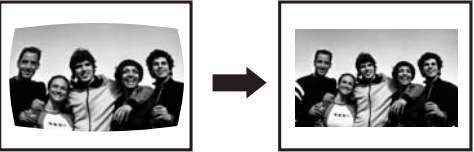
<p>• Pincushion distortion</p> 	<ol style="list-style-type: none"> 1. Go to the Display > Keystone menu. 2. Highlight Pincushion Correction and press ▶/▶ repeatedly until the image's shape becomes square.
<p>• Barrel distortion</p> 	<ol style="list-style-type: none"> 1. Go to the Display > Keystone menu. 2. Highlight Pincushion Correction and press ◀/◀ repeatedly until the image's shape becomes square.

Optimizing the image

To optimize the image, use the remote control or on-screen menus. For the operation of on-screen menus, please refer to "[Using the menus](#)" on page 36.

The following steps are optional. You do not need to follow every step. It depends on the image quality you desire.

1. Selecting a picture mode

Select a picture mode on the remote control, or in the **Picture--Basic > Picture Mode** menu. You can also press **MODE** on the control panel or remote control repeatedly until your desired mode is selected. There are 7 modes available for each input. These modes consist of preset values suitable for various projection situations as described below:

- **Dynamic Mode:** Maximizes the brightness of the projected image. This mode is suitable for environments where extra-high brightness is required, such as using the projector in well lit rooms.
- **Cinema Mode:** With well-balanced color saturation and contrast with a low brightness level. This is most suitable for enjoying movies in a totally dark environment (as you would find in a commercial cinema).
- **Standard Mode:** Is slightly brighter than Cinema Mode, and suitable for use in rooms where there is a small amount of ambient light.
- **Photo Mode:** Designed for viewing digital pictures in a living room.
- **User 1/User 2/User 3 Modes:** Recalls the customized settings. See "[Setting the User 1/User 2/User 3 modes](#)" on page 29 for details. These three modes can also be selected directly by pressing the Memory 1/2/3 buttons on the remote control.

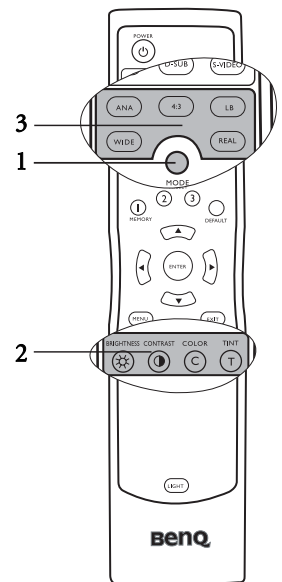

☞ If you are not satisfied with the picture quality made by the preset picture modes. You can manually adjust the settings through the **Picture--Basic** and **Picture--Advanced** menus. See "[Picture--Basic menu](#)" on page 37 and "[Picture--Advanced menu](#)" on page 38 for details.

Setting the User 1/User 2/User 3 modes

There are three user-definable modes if the current available picture modes are not suitable for your need. You can use one of the picture modes (except the User 1/2/3) as a starting point and customize the settings.

1. Go to the **Picture--Basic > Picture Mode** menu.
2. Press **◀Left** or **▶Right** to select **User 1**, **User 2** or **User 3**.
3. Press **▼Down** to highlight **Load Settings From** and press **ENTER**.
4. Press **▲Up** or **▼Down** to highlight a picture mode that is closest to your need and press **ENTER**.
5. Press **EXIT** to go back to the previous page and press **▼Down** to select a menu item to be changed and adjust the value with **◀Left** or **▶Right**.
6. You can also press **EXIT** and then press **▶Right** to go to the **Picture--Advanced** menu for further picture setting adjustments. See "[Advanced picture quality controls](#)" on page 30 for details.

Renaming the User 1/User 2/User 3 modes

To rename the user-definable modes, you can perform the following steps.

1. Go to the **Picture--Basic > Rename User Mode** menu and press **ENTER**.
2. Press **▲Up** or **▼Down** to highlight **User 1**, **User 2** or **User 3** and press **ENTER**.
3. Press **◀Left** or **▶Right** to select a character position.
4. Assign a letter or a number to this character position by pressing **▲Up** or **▼Down** repeatedly. Press **▲Up** to select individual letters in alphabetical order, or press **▼Down** to select in reverse order. Capital letters, lowercase letters, numbers from 0 to 9, and a blank space are provided to you.
5. Repeat Step 3 and 4 until you are satisfied with the new name.

- ☞ • **The maximum length is 12 digits.**
 - **The first character cannot be a space.**
6. When finished, press **ENTER** to save the settings.

2. Adjusting picture quality

You can adjust Brightness, Contrast, Color, Tint and Sharpness settings using the **Picture--Basic** menu or with the remote control. See "[Picture--Basic menu](#)" on page 37 for details.

- ☞ • **All settings in the Picture--Basic menu will take effect right away and be saved to the picture mode that you select.**
- **Some picture adjustments are available only when certain input ports are in use. Unavailable adjustments are not shown on the screen.**

3. Selecting the aspect ratio

The "aspect ratio" is the ratio of the image width to the image height. Most analog TV signals and computers are in 4:3 ratio and digital TV and DVDs are usually in 16:9 ratio.

With the advent of digital signal processing, digital display devices like this projector can dynamically stretch and scale the image output to a different aspect than that of the image input source. Images can be stretched in a linear manner so the whole of the image is stretched equally, or non-linearly, which distorts the image.

You can change the projected image ratio (no matter what aspect the source is) by using the Aspect buttons on the remote control or in the **Display > Aspect Ratio** OSD menu. Select an aspect ratio to suit the format of the video signal and your display requirements. There are five aspect ratios available:

☞ In the pictures below, the black portions are inactive areas and the white portions are active areas.

1. **Anamorphic:** (displayed as "ANA" on the remote control) Scales an image so that it is displayed in the center of the screen with a 16:9 aspect ratio.

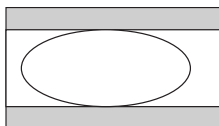

2. **4:3:** Scales an image so that it is displayed in the center of the screen with a 4:3 aspect ratio.

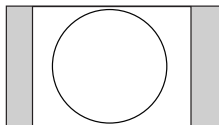

3. **Letterbox:** (displayed as "LB" on the remote control) Enlarges an image with letterbox format to display it in full-screen format with a 16:9 aspect ratio. The upper and lower portions of the image are cropped.

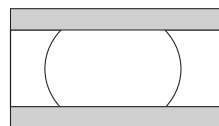

4. **Wide:** A 4:3 aspect ratio image is enlarged NON-linearly in horizontal direction to accommodate 16:9 full-screen display. This stretches only the right and left sides of the image; the central part is unchanged.

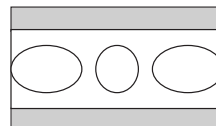

5. **Real:** One-to-one mapping is performed on the input signal without any scaling with the image displayed at the center of the screen.

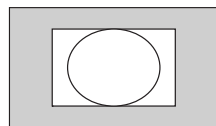

The **Anamorphic** setting stretches and resizes linearly, except that it treats the vertical and horizontal dimensions independently. It stretches the height of the source image until it reaches the full projected height, and stretches the width of the source image until it reaches the full projected width. This may alter the projected aspect, depending upon the original aspect of the source image. Anamorphic is most suitable for images which are already in a 16:9 aspect, like high definition TV, as it displays them without aspect alteration.

The **4:3** setting is most suitable for 4:3 images like standard definition TV and 4:3 aspect DVD movies, as it displays them without aspect alteration.

The **Letterbox** setting resizes an image proportionately both vertically and horizontally from the width of a 4:3 aspect to the width of a 16:9 aspect and centers it on-screen. This produces an image greater in height than can be displayed, so part of the image is lost (not displayed) along the top and bottom edges of the projection. This is suitable for the display of movies which are presented in letterbox format (with black bars top and bottom).

The **Wide** setting stretches the image horizontally in a non-linear manner, that is, the edges of the image are stretched more than the centre of the image, to prevent distortion of the central part of the image. This is suitable for occasions where you want to stretch the width of a 4:3 aspect image to the width of a 16:9 aspect screen. It does not alter the height. Some widescreen movies have been produced with their width squashed down to the width of a 4:3 aspect, and are best viewed when restretched back to their original width using the Wide setting.

The **Real** setting displays the image in a one-to-one pixel mapping without alteration or resize in the centre of the projection. This is most suitable for use with PC and RGBHD source inputs.

Advanced picture quality controls

There are more advanced user-definable functions in the **Picture--Advanced** menu.

☞ All settings in the **Picture--Advanced** menu will take effect right away and be saved to the picture mode that you select.

Setting black level

1. Go to the **Picture--Advanced** menu and highlight **Black Level**.
2. Press ◀ **Left** or ▶ **Right** to select **0 IRE** or **7.5 IRE**.

The grayscale video signal is measured in IRE units. In some areas which use NTSC TV standard, the grayscale is measured from 7.5 IRE (black) to 100 IRE (white); however, in other areas which use PAL equipment or Japanese NTSC standard, the grayscale is measured from 0 IRE (black) to 100 IRE (white). We suggest that you check the input source if it is with 0 IRE or 7.5 IRE, then select accordingly.

Adjusting picture clarity

1. Go to the **Picture--Advanced** menu and highlight **Clarity Control**.
2. Press **ENTER**.
3. Press **▲Up** or **▼Down** to highlight one of the following functions and press **◀Left** or **▶Right** to adjust the setting.
 - **Noise Reduction:** Reduces electrical image noise. The higher the setting, the less the noise.
 - **Detail Enhancement:** The higher the setting, the more details the image reveals.
 - **Luma Transmission:** Enhances contour details. The higher the setting, the more distinct the effect.
 - **Chroma Transmission:** Reduces color smear. The higher the setting, the more distinct the effect.
4. Repeat Step 3 until you are satisfied with the picture clarity.

Selecting a color temperature

1. Go to the **Picture--Advanced** menu and highlight **Color Temp**.
2. Press **◀Left** or **▶Right** to select from one of the following settings.
 - **Lamp Native:** With factory default color temperature and higher brightness. This setting is suitable for environments where high brightness is required, such as using the projector to project slides in well lit rooms.
 - **Warm:** Makes pictures appear reddish white.
 - **Normal:** Maintains normal colorings for white.
 - **Cool:** With the highest color temperature, making pictures appear bluish white.
 - **User 1/User 2/User 3:** recalls the customized settings in the **Color Temp User Fine Tuning** menu. See "[Setting a preferred color temperature](#)" on page 31 for details.

About color temperatures:

There are many different shades that are considered to be “white” for various purposes. One of the common methods of representing white color is known as the “color temperature”. A white color with a low color temperature appears to be reddish white. A white color with a high color temperature appears to have more blue in it.

Setting a preferred color temperature

This function is only available when the color temperature is set as User 1/User 2/User 3.

1. Go to the **Picture--Advanced** menu and highlight **Color Temp**.
2. Press **◀Left** or **▶Right** to select **User 1**, **User 2** or **User 3**.
3. Press **▼Down** to highlight **Color Temp User 1/2/3 Fine Tuning**.
4. Press **▲Up** or **▼Down** to highlight the item you want to change and adjust the values with **◀Left** or **▶Right**.
 - **Red Gain:** Adjusts the contrast level of Red.
 - **Green Gain:** Adjust the contrast level of Green.
 - **Blue Gain:** Adjusts the contrast level of Blue.
 - **Red Offset:** Adjusts the brightness level of Red.
 - **Green Offset:** Adjusts the brightness level of Green.
 - **Blue Offset:** Adjusts the brightness level of Blue.
5. Press **EXIT/MENU** to exit and save the settings.

Color management

In most installation situations, color management will not be necessary, such as in classroom, meeting room, or lounge room situations where lights remain on, or where building external windows allow daylight into the room.

Only in permanent installations with controlled lighting levels such as boardrooms, lecture theaters, or home theaters, should color management be considered. Color management provides fine color control adjustment to allow for more accurate color reproduction, should you require it.

Proper color management can only be achieved under controlled and reproducible viewing conditions. You will need to use a colorimeter (color light meter), and provide a set of suitable source images to measure color reproduction. These tools are not provided with the projector, however, your projector supplier should be able to provide you with suitable guidance, or even an experienced professional installer.

The Color Management provides six sets (RGBCMY) of colors to be adjusted. When you select each color, you can independently adjust its range and saturation according to your preference.

If you have purchased a test disc which contains various color test patterns and can be used to test the color presentation on monitors, TVs, projectors, etc. You can project any image from the disc on the screen and enter the Color Management menu to make adjustments.

To adjust the settings:

1. Go to the **Picture--Advanced** menu and highlight **Color Management**.
2. Press **ENTER** and the **Color Management** page displays.
3. Highlight **Primary Color** and press **◀ Left** or **▶ Right** to select a color from among Red, Yellow, Green, Cyan, Blue, or Magenta.
4. Press **▼** to highlight **Range** and press **◀ Left** or **▶ Right** to select its range. Increase in the range will include colors consisted of more proportions of its two adjacent colors.
Please refer to the illustration to the right for how the colors relate to each other.

For example, if you select Red and set its range at 0, only pure red in the projected picture will be selected. Increasing its range will include red close to yellow and red close to magenta.

5. Press **▼** to highlight **Saturation** and adjust its values to your preference by pressing **◀ Left** or **▶ Right**. Every adjustment made will reflect to the image immediately.
For example, if you select Red and set its value at 0, only the saturation of pure red will be affected.

6. Repeat steps 3, 4 and 5 for other color adjustments.
7. Make sure you have made all of the desired adjustments. If you are not satisfied with the result, you may go to the **Picture--Basic > Reset Picture Settings** menu, enter it for returning to the factory preset values.
8. Press **EXIT/MENU** to exit and save the settings.

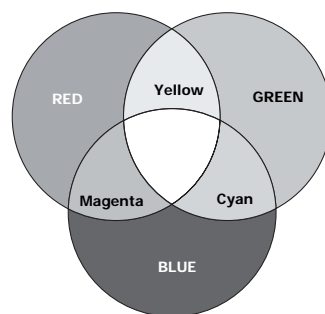

Activating the blue filter

After making color adjustments, you can project the color bar test image from the test disc to test the level of color saturation by activating the blue filter instead of looking through color filters. Turning on the blue filter will disable all Red and Green channel output, allowing only the Blue color to be displayed on the screen. Please refer to the instructions on the test disc for how to check the accuracy of different colors.

To activate the blue filter:

1. Go to the **Picture--Advanced** menu and highlight **Blue Filter**.
2. Press **◀ Left** or **▶ Right** to toggle the blue filter on and off. The setting will take effect immediately.

Operating in a high altitude environment

We recommend that you use the High Altitude Mode when your environment is higher than 3200 feet above sea level, or is hotter than 40°C.

To activate High Altitude Mode:

1. Press **MENU** to turn the OSD menu on and press **◀Left** or **▶Right** to select **Advanced Setup**.
2. Press **▲Up** or **▼Down** to highlight **High Altitude Mode**.
3. Press **◀Left** or **▶Right** to select **On**.
4. A confirmation message displays. Highlight **Yes** and press **ENTER**.

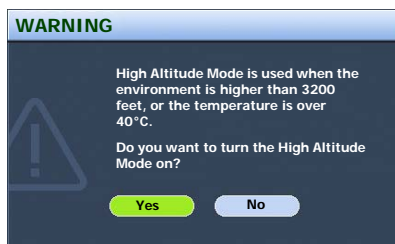

Operation under "High Altitude Mode" may cause a higher decibel operating noise level because of increased fan speed necessary to improve overall system cooling and performance.

If you use this projector under other extreme conditions excluding the above, it may display auto shut-down symptoms, which is designed to protect your projector from over-heating. In cases like this, you should switch to High Altitude mode to solve these symptoms. However, this is not to state that this projector can operate under any and all harsh or extreme conditions.

Searching for details on the projected image

If you need to find the details on the projected image, you can perform the following steps.

1. Go to the **Display > Digital Zoom** menu.
2. Press **◀Left** or **▶Right** on the projector or remote control repeatedly to magnify the image until you are satisfied with the image size. The image can be magnified up to 300%.
3. Press **▼Down** to highlight **Pan** and press **ENTER** to display the Pan page.
4. Use the **Keystone/Arrow** buttons (◻ / ▲, ◻ / ◀, ◻ / ▼, ◻ / ▶) on the projector or remote control to navigate the image.
5. Press **EXIT** to go back to the previous page.
6. To restore the image to its original size, go to the **Display > Digital Zoom** menu and press **◀Left** to reduce the size of the image.

Creating your own startup screen

In addition to selecting the projector preset startup screen from between BenQ logo and Blue screen, you can make your own startup screen that is an image projected from your computer or video source.

1. Project the image you want to use as your startup screen from either a computer or video source.
2. Go to the **System Setup > My Screen** menu, press **ENTER**.
3. A confirmation message displays. Press **ENTER** again.
4. The message '**Screen Capturing**' displays while the projector is processing the image. Please wait.
5. If the action is successful, you see the message '**Captured Succeeded**' on the screen. The captured image is saved as My Screen.
6. To view the captured image displayed as the startup screen, set **My Screen** in the **System Setup > Splash Screen** menu and restart the projector.

In the unlikely event, the capturing action failed. If so, change your target image.

Personalizing the projector menu display

The On Screen Display (OSD) menus can be set according to your preferences. These settings do not affect the projection settings, operation, or performance.

- **Language** in the **System Setup** menu sets your familiar language for the on-screen menus.
- You can select the projector's **Background Color** from black, blue or purple in the **System Setup** menu.
- **Menu Display Time** in the **System Setup > Menu Settings** menu sets the length of time the OSD will remain active after the last button press.
- **Menu Position** in the **System Setup > Menu Settings** menu adjusts the OSD position on the screen.

Turning the power off

1. Press **POWER** on the projector or remote control and a prompt message appears. Press **POWER** a second time to turn the projector off.
2. The Power indicator light flashes orange, the lamp shuts down, and the fans continue to run for approximately 140 seconds to cool down the projector.

⚠ To protect the lamp, the projector will not respond to any commands during the cooling process.

3. The Power indicator light is a steady orange once the cooling process has finished and fans stop.
4. Disconnect the power cord from the wall socket.

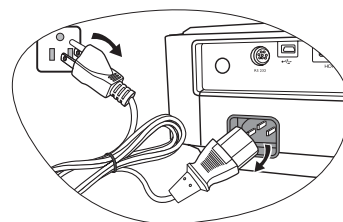
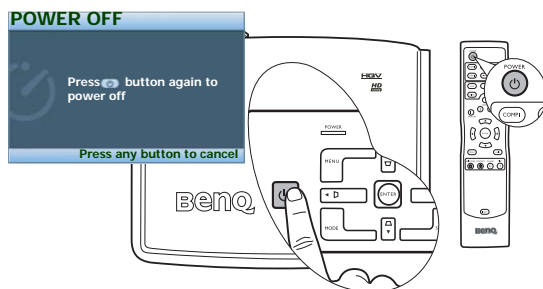

On Screen Display (OSD) structure

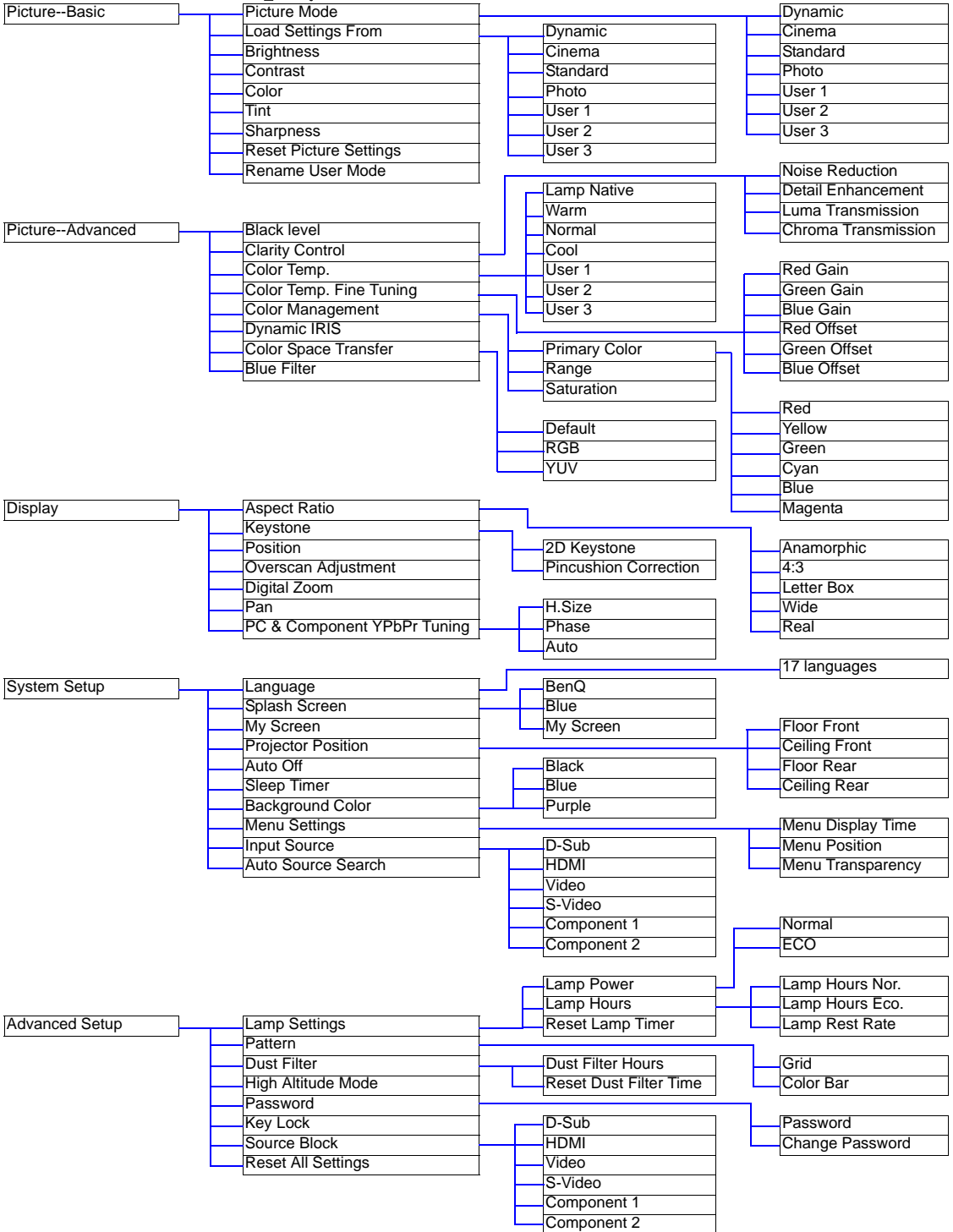

Information	Source
	Picture Mode
	Resolution
	Lamp Hours Nor.
	Lamp Hours Eco.
	Lamp Rest Rate
	Dust Filter Hour

If there is no equipment connected or no signal detected, limited menu items are accessible.

Using the menus

The projector is equipped with on-screen display (OSD) menus for making various adjustments and settings. There are 17 different menu languages. See page 39 for more details.

Below is the overview of the English OSD menu.



The following example describes the adjustment of the keystone.

1. Press **MENU** on the projector or remote control to turn the OSD menu on.
4. Press **ENTER** and press **▲ Up/ ▼ Down** to select **2D Keystone**.



2. Use **◀ Left/ ▶ Right** to select the **Display** menu.
3. Press **▲ Up/ ▼ Down** to select **Keystone**.

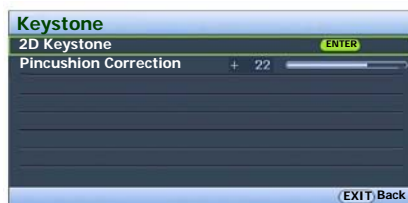

5. Press **ENTER** to display the keystone correction page.





6. Based on the image shape displayed on the screen, press the keystone buttons (**◻ / ▲ Up**, **◻ / ◀ Left**, **◻ / ▼ Down**, **◻ / ▶ Right**) to adjust the image to a rectangular or square one.
7. Press **EXIT/MENU** on the projector or remote control to exit and save the settings.

Picture--Basic menu

The Picture--Basic menu allows you to adjust the finer details of the projected image quality.

Before making adjustments, you are suggested to choose a desired picture mode in this menu which has set some certain values in order to meet different lighting environment and presentation purposes.

FUNCTION (default setting / value)	DESCRIPTION
Picture Mode (D-sub (Analog RGB)/HDMI: Standard; S-Video/ Component/ Video: Standard)	Picture modes are provided so you can optimize your projector image set-up to suit your program type. See "1. Selecting a picture mode" on page 28 for details.
Load Settings From	Loads the settings from one of the preset picture modes and three User Modes. This function is only available when the picture mode is set as User 1/2/3. See "Setting the User 1/User 2/User 3 modes" on page 29 for details.
Brightness (50)	Adjusts the brightness of the image. The higher the value, the brighter the image. And lower the value, the darker the image. Adjust this control so the black areas of the image appear as black and that detail in the dark areas is visible. 
Contrast (50)	Adjusts the degree of difference between dark and light in the image. The higher the value, the greater the contrast. 
Color (50)	Increase or decrease the color intensity of the image. The higher the value, the more vivid and brighter the color.
Tint (0)	Adjusts the color tones of the image. The higher the value, the more greenish the picture becomes. The lower the value, the more purplish the picture becomes.
Sharpness (0)	Adjusts the picture sharpness. The higher the value, the sharper the picture.
Reset Picture Settings	Returns the image settings of the current picture mode to the factory preset values.  If the User 1/User 2/User 3 has been renamed, the new name will remain unchanged.
Rename User Mode	Changes User 1/2/3 to your desired name. See "Renaming the User 1/User 2/User 3 modes" on page 29 for details.

Picture--Advanced menu

The Picture--Advanced menu allows you to adjust the finer details of the projected image quality.

FUNCTION (default setting / value)	DESCRIPTION
Black Level (0 IRE)	See "Setting black level" on page 30 for details.
Clarity Control	See "Adjusting picture clarity" on page 31 for details.
Color Temp.	See "Selecting a color temperature" on page 31 for details.
Color Temp. Fine Tuning	See "Setting a preferred color temperature" on page 31 for details.
Color Management	See "Color management" on page 32 for details.
Dynamic IRIS (On)	Toggles Dynamic IRIS between On and Off .
Color Space Transfer (Default)	When using certain European TV setup boxes found with YUV color encoding system, press ◀ Left or ▶ Right to select YUV as this will allow images to display normally.
Blue Filter (Off)	See "Activating the blue filter" on page 32 for details.

Display menu

Use this menu to set the way that the projector displays the picture.

FUNCTION (default setting / value)	DESCRIPTION
Aspect Ratio (Anamorphic)	There are a few aspect ratios that can be selected for different input signals. See "3. Selecting the aspect ratio" on page 29 for details.
Keystone (0)	<p>Corrects for trapezoidal distortion resulting from the angle of projection and pincushion distortion of the image.</p> <ul style="list-style-type: none"> • 2D Keystone (0): Corrects any keystone of the image. See "Correcting two-dimensional keystone" on page 26 for details. • Pincushion Correction (0): Corrects any pincushion distortion of the image. See "Correcting pincushion and barrel distortion" on page 27 for details.
Position (0)	<p>Displays the position adjustment page. To move the projected image, use the directional arrow buttons. The values shown on the lower position of the page change with every button press you made until they reach their maximum or minimum.</p> <p> This function is only available with a D-sub (analog RGB) signal selected.</p>
Overscan Adjustment (0)	Slightly magnifies and stretches the picture to remove the less brighter image areas commonly found towards the four edges.
Digital Zoom (100%)	Magnifies the projected image. See "Searching for details on the projected image" on page 33 for details.

Pan (Central)	Displays the Pan page for searching the details of the projected image by using the directional arrow buttons on the projector or remote control after the image is magnified. See " Searching for details on the projected image " on page 33 for details.
PC & Component YPBPr Tuning	The following settings are only available with a PC or DTV RGB signal selected. <ul style="list-style-type: none"> • H. Size (0): Adjusts the frequency of the sampling clock that captures the input signal. • Phase (0): Adjusts the phase of the clock. • Auto: Adjusts the phase, and frequency automatically.

System Setup menu

This menu contains items necessary for basic image setup.

FUNCTION (default setting / value)	DESCRIPTION
Language (English)	Sets the language for the OSD menus. There are 17 languages for your choice: English (default), French, German, Italian, Spanish, Russian, Traditional Chinese, Simplified Chinese, Japanese, Korean, Swedish, Dutch, Turkish, Czech, Portuguese, Thai, and Polish.
Splash Screen (BenQ)	Allows you to select which logo screen will display during projector startup. Three options are available: BenQ logo, Blue screen or My Screen.
My Screen	Captures and stores the projected image as My Screen. See " Creating your own startup screen " on page 33 for details.
Projector Position (Floor Front)	The projector can be installed on a ceiling or behind a screen, or with one or more mirrors. There are four settings for choice. Contact your dealer for the ceiling mount bracket if you need to install the projector on a ceiling. See " Choosing a location " on page 14 for details.
Auto Off (Disable)	This function allows the projector to turn off automatically after your last button press when no input signal is detected. To set the Auto Off time, go to the System Setup > Auto Off menu and press ◀Left or ▶Right to set a time from 5 to 30 minutes in 5-minute increments.  The setting will remain the next time you turn on the projector.
Sleep Timer (Disable)	Sets the auto-shutdown timer. The timer can be set to a value between 30 minutes and 360 minutes.
Background Color (Blue)	Allows you to choose the color of the background screen that will be displayed when there is no input signal detected.
Menu Settings	<ul style="list-style-type: none"> • Menu Display Time (10 sec): Sets the length of time the OSD will remain active after your last button press. The range is from 5 to 30 seconds. • Menu Position (Center): Adjusts the horizontal and vertical position of the OSD. • Menu Transparency (0): Adjusts the transparency level of the OSD.
Input Source	Selects the input signal. See " Switching input signal " on page 25 for details.
Auto Source Search (On)	Sets whether the projector searches automatically for input signals. See " Activating automatic source search " on page 25 for details.

Advanced Setup menu

FUNCTION (default setting / value)	DESCRIPTION
Lamp Settings	<ul style="list-style-type: none"> • Lamp Power (Normal): Press ◀ Left or ▶ Right on the projector or remote control to set Normal or Economic as the power type of your projection. Using Eco mode reduces system noise and reduces power consumption by 20%. If this mode is activated, the light output will be reduced and result in darker projected images. ☞ Setting the projector in Economic mode extends the lamp timer automatic shutdown feature. For more information on how the total lamp hour is calculated, see "Calculation of lamp hour" on page 44 for details. • Lamp Hours: <ol style="list-style-type: none"> i. Lamp Hours Nor.: Shows the total time of the lamp has been used in normal mode. ii. Lamp Hours Eco.: Shows the total time of the lamp has been used in economic mode. iii. Lamp Rest Rate: Shows the percentage of the rest lamp life. • Reset Lamp Timer: Resets the lamp timer. This should only be done after the lamp has been replaced. See "Replacing the lamp" on page 45 for details.
Pattern	<p>Use the patterns when installing the projector, even if there is no input signal.</p> <ul style="list-style-type: none"> • Grid: Press ENTER to display the grid test pattern. It helps you adjust the image size and the focus to ensure that the projected image is free of distortion. • Color Bar: Press ENTER to display the color bar test pattern. After making color adjustments, you can display this test pattern to check that the colors are to your liking.
Dust Filter	<ul style="list-style-type: none"> • Dust Filter Hours: Shows the total time of the filter has been used. • Reset Dust Filter Timer: Reset the dust filter timer. This should only be done after the filter has been replaced. See "To clean the filter:" on page 43 for details.
High Altitude (Off)	<p>This item is designed for those who use the projector in extreme environments, like high temperature or high altitude. We recommend you select Yes when your environment is higher than 3200 feet, or is hotter than 40°C. See "Operating in a high altitude environment" on page 33 for details.</p>
Password	<ul style="list-style-type: none"> • Password (Off): Limits use of the projector to only those who know the correct password. When the function is activated for the first time, you have to set a password for it. See "Setting a password" on page 24 for details. Once the password is set and this function is selected, the projector is password-protected. Users who do not know the correct password can not use the projector. The password can be entered by using either the buttons on the projector or the remote control. • Change Password: You will be asked to enter the current password before changing to a new one. See "Changing the password" on page 25 for details.
Key Lock (Off)	<p>Disables or enables all panel key functions except POWER on the projector and buttons on the remote control. To release key lock, press and hold EXIT on the control panel or remote control for 5 seconds.</p>
Source Block	<p>Sets whether one or more than one source to be skipped or searched when the projector is detecting input signals. See "Speeding up the process of source search" on page 26 for details.</p>

Reset All Settings	Returns all settings to the factory preset values.  The following settings will still remain: Phase, Projector Position, Language, Password and High Altitude Mode.
---------------------------	--

Information menu

FUNCTION (default setting / value)	DESCRIPTION
Source	Shows the current signal source.
Picture Mode	Shows the selected mode in the Picture--Basic menu.
Resolution	Shows the resolution of the input signal.
Lamp Hours Nor.	Shows the total time of the lamp has been used in normal mode.
Lamp Hours Eco.	Shows the total time of the lamp has been used in economic mode.
Lamp Rest Rate	Shows the percentage of the rest lamp life.
Dust Filter Hour	Shows the total time of the filter has been used.

7 Maintenance

Care of the projector

Your projector needs little maintenance. The only thing you have to do on a regular basis is keep the lens clean and clean or replace the air filter. Never remove any parts of the projector except the lamp or the air filter. Contact your dealer or local BenQ Customer Service Centre if the projector fails to operate as expected.

Cleaning the lens

Clean the lens whenever you notice dirt or dust on the surface. Before you attempt to clean the lens, turn the projector off, unplug the power cable, and leave it several minutes to cool completely.

1. Use a canister of compressed air to remove dust. (Available from building hardware or photographic suppliers.)
2. If there is stubborn dirt or smudge marks, use a proper photographic lens brush or moisten a clean soft lens cloth with lens cleaner to gently wipe the lens surface.

⚠ Never touch the lens with your finger or rub the lens with abrasive materials. Even paper towels can damage the lens coating. Only ever use a proper photographic lens brush, cloth, and cleaning solution. Do not attempt to clean the lens whilst the projector is switched on or is still hot from previous use.

Storing the projector

If you need to store the projector for an extended time, please:

1. Make sure the temperature and humidity of the storage area are within the recommended range for the projector. Please refer to the Spec. page in this manual or consult your dealer about the range.
2. Retract the adjuster feet.
3. Remove the batteries from the remote control.
4. Pack the projector in its original packing or equivalent.

Transporting the projector

It is recommended that you ship the projector with its original packing or equivalent. When you carry the projector yourself, please use a soft carry case.

Cleaning and replacing the dust filter

It is necessary to clean the dust filter periodically every 1000 hours use. You can use the **Advanced Setup > Dust Filter > Dust Filter Hours** menu or the **Information** menu to check how long the filter has been used. If the filter is not cleaned, it can become clogged with dust and prevent proper ventilation. This can cause overheating and a malfunction of the projector.

Should the projector filter become seriously clogged with dust, it can cause over-heating inside of the projector. You will see the message pictured to the right before the projector shuts down and powers off.



To clean the filter:

1. Shut down the projector if turned on and wait until the fans stop running.
2. Disconnect the projector from any cables.
3. Turn the projector over. Draw the dust filter grill from the bottom side of the projector.

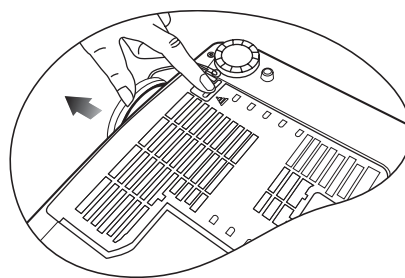

4. Use a small vacuum cleaner (designed for computers and other office equipment) or use a soft brush (such as a clean artist's paintbrush) to vacuum or sweep the dust away.
 - If the dirt is difficult to remove or the filter is broken, you should replace it.

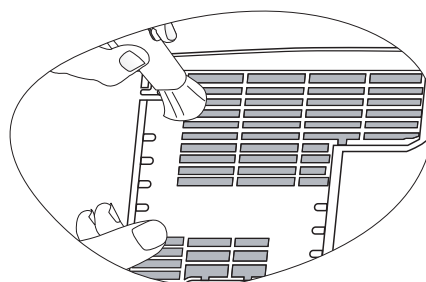

5. Re-install the filter grill securely.

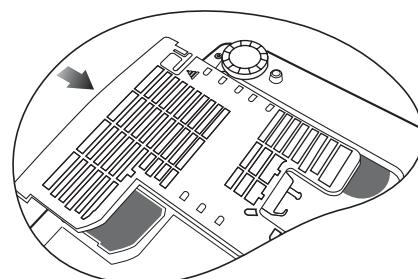

6. Reapply power and turn the projector on.
 - If the filter grill is not correctly seated in place, you will be reminded by a message displayed on the screen every three minutes until **ENTER** on the projector or remote control is pressed.
Please check if the filter is well attached.
 - The projector will automatically shut down within one minute if there has been no further action taken. Re-install the filter securely, then turn on the power again.
7. Reset the dust filter timer
 - i. Press **MENU** to open the OSD menu.
 - ii. Go to the **Advanced Setup > Dust Filter** menu and press **ENTER**.
 - iii. Highlight **Reset Dust Filter Timer** and press **ENTER**.
 - iv. A warning message displays asking if you want to reset the dust filter timer.
 - v. Highlight **Reset** and press **ENTER** to reset the filter timer to "0".

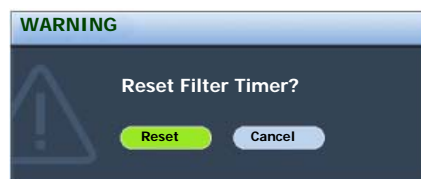

Lamp Information

Calculation of lamp hour

When the projector is in operation, the duration (in hours) of lamp usage is automatically calculated by the built-in timer. The method of calculating the equivalent lamp hour is as follows:

Total (equivalent) lamp hour

= 1 (hours used in Economic mode) + 3/2 (hours used in normal mode)

 See "**Lamp Settings**" on page 40 for more information on Economic mode.

The lamp hour in Economic mode is calculated as 2/3 of that in normal mode. That is, using the projector in Economic mode helps to extend the lamp hour by 1/3.

Warning message

When the **Lamp indicator** lights up red or a message appears suggesting it is time to replace the lamp, please install a new lamp or consult your dealer. An old lamp may cause a malfunction in the projector and in some instances the lamp may explode.

For more detailed information on projector warnings, please refer to "**Indicators**" on page 47.

 **The Lamp indicator light and Temperature warning light will light up if the lamp becomes too hot. Turn the power off and let the projector cool for 45 minutes. If the Lamp or Temp indicator still lights up after turning the power back on, please contact your dealer.**

The following Lamp warning displays will remind you to change the lamp.

Message	Status
<p>WARNING</p> <p>NOTICE: Order replacement lamp</p> <p>Lamp > 2000hrs</p> <p>Projector will stop at 3000hrs</p> <p>OK</p>	Total (equivalent) lamp hour has reached 2000 hours. Install a new lamp for optimal performance.
<p>WARNING</p> <p>NOTICE: Replace lamp soon</p> <p>Lamp > 2950hrs</p> <p>Projector will stop at 3000hrs</p> <p>OK</p>	Total (equivalent) lamp hour has reached 2950 hour. A new lamp should be fitted to avoid the inconvenience when the projector runs out of lamp time.
<p>WARNING</p> <p>NOTICE: Replace lamp now</p> <p>Lamp > 3000hrs</p> <p>Lamp-usage time exceeded</p> <p>OK</p>	Total (equivalent) lamp hour has reached 3000 hours. It is strongly recommended that you replace the lamp at this age. The lamp is a consumable item. With the usage time increase, the lamp brightness diminished gradually. This is normal lamp behaviour. You can replace the lamp whenever you notice that the brightness level has significantly diminished. If the lamp is not replaced beforehand, it must be replaced after 3000 hours usage

<p>WARNING</p> <p>NOTICE: Lamp-usage time exceeded</p> <p>Replace lamp (refer to User's Manual) then reset lamp timer</p> <p>OK</p>	<p>If this warning message displays, the projector will shut down in 40 seconds. The lamp MUST be replaced before the projector will operate normally.</p>
---	---

Replacing the lamp

- ⚠ • **To reduce the risk of electrical shock, always turn the projector off and disconnect the power cord before changing the lamp.**
- **To reduce the risk of severe burns, allow the projector to cool for at least 45 minutes before replacing the lamp.**
- **To reduce the risk of injuries to fingers and damage to internal components, use caution when removing lamp glass that has shattered into sharp pieces.**
- **To reduce the risk of injuries to fingers and/or compromising image quality by touching the lens, do not touch the empty lamp compartment when the lamp is removed.**
- **This lamp contains mercury. Consult your local hazardous waste regulations to dispose of this lamp in a proper manner.**

1. Turn the power off and disconnect the projector from the wall socket. Turn off all connected equipment and disconnect all other cables.
2. Turn the projector over. Then loosen the screw on the lamp cover.

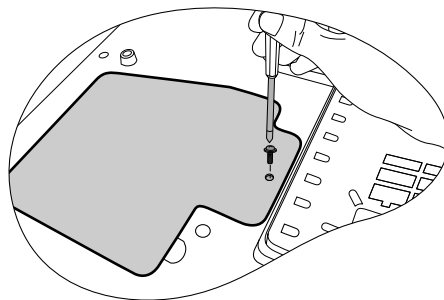

3. Remove the lamp cover.

⚠ **Do not turn the power on with the lamp cover removed.**

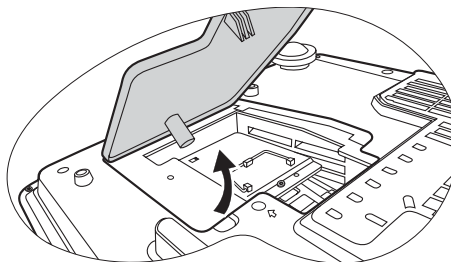

4. Loosen the screws that hold the lamp to the projector. If the screws are not loosened completely, they could injure your fingers. It is strongly recommended that you use a magnetic-head screwdriver to retain the screw should it come loose.

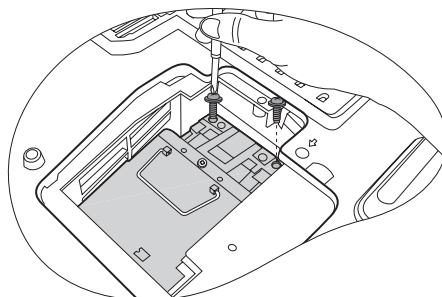

5. Lift the handle so that it stands up. Use the handle to slowly pull the lamp out of the projector.



- **Pulling it too quickly may cause the lamp to break and scatter broken glass in the projector. To reduce the risk of injuries to fingers and damage to internal components, use caution when removing lamp glass that has shattered.**

- **Do not place the lamp in locations where water might splash on it, children can reach it, near or above heat sources, or near flammable materials.**

- **Do not insert your hand into the projector when the lamp is removed. If you touch the optical components inside, it could cause blurred images.**

6. As shown in the figure, lower the new lamp first into the connector on the projector and align the two holes on the lamp with the locators on the projector.

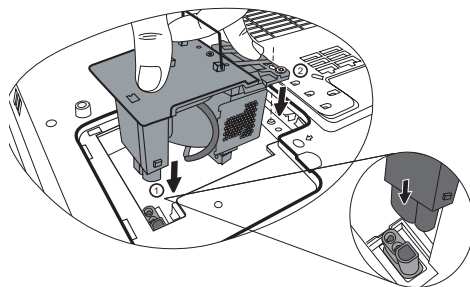
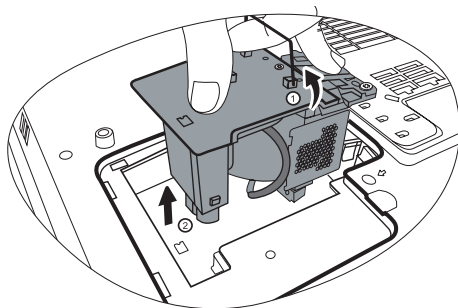

7. Push the lamp downwards to ensure it is firmly secured to the projector.

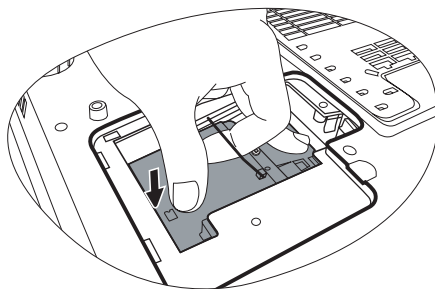

8. Tighten the screws securing the lamp box.

9. Re-install the lamp cover.

10. Tighten the screw on the lamp cover.



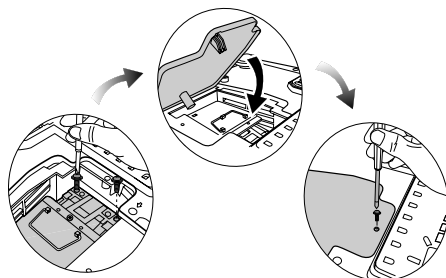

- **Please be careful to not over-tighten the screws.**

- **Loose screws may cause a bad connection, which could result in malfunction.**

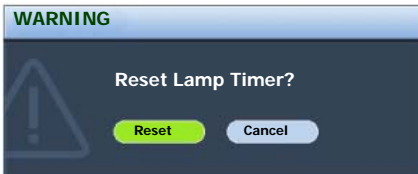

11. Turn the power on and reset the lamp time.
 - i. Press **MENU** to open the OSD menu.
 - ii. Go to the **Advanced Setup > Lamp Settings** menu and press **ENTER**.
 - iii. Highlight **Reset Lamp Timer** and press **ENTER**.
 - iv. A warning message displays asking if you want to reset the lamp timer.
 - v. Highlight **Reset** and press **ENTER** to reset the lamp timer to "0".



 **Do not reset the lamp timer if the lamp has not been replaced as this could cause damage.**

Temperature information



When the Temperature warning light is on, it is warning you of the following possible problems:















1. The internal temperature is too high.
2. The fans are not working.

Turn the projector off and contact qualified service personnel for further help. For more detailed information, please refer to "[Indicators](#)" on page 47.

Indicators

Illustration

- **Blank** -: Light OFF
- : Light flashing
- : Light ON
- **O**: Orange light
- **R**: Red light
- **G**: Green light

Light			Status & Description
Power	Temp	Lamp	
Power events			
			The projector has just been connected to a power outlet.
			Main power switch on
	-	-	Stand-by mode.
	-	-	Powering up.
	-	-	Normal operation.
	-	-	<ul style="list-style-type: none"> • The projector needs 140 seconds to cool down as it was abnormally shut down without the normal cooling down process. Or • The projector needs to cool for 90 seconds after the power is turned off.
	-	-	The projector has shutdown automatically. If you try to restart the projector, it will shutdown again. Please contact your dealer for assistance.
Lamp events			
	-	-	Lamp hour warning/Lamp hour error.
	-		The projector has shutdown automatically. If you try to restart the projector, it will shutdown again. Please contact your dealer for assistance.
-	-		<ol style="list-style-type: none"> 1. The projector needs 90 seconds to cool down. Or 2. Please contact your dealer for assistance.

Light			Status & Description
Power	Temp	Lamp	
Thermal events			
-	R	-	<p>The projector has shutdown automatically. If you try to re-start the projector, it will shutdown again. Please contact your dealer for assistance.</p>
-	R	R	
-	R	G	
	R	O	
R	R	R	
R	R	G	
R	R	O	
G	R	R	
G	R	G	
G	R	O	
O	R	R	
O	R	G	
O	R	O	
-	G	R	
-	G	G	

8 Troubleshooting

⑦ THE PROJECTOR DOES NOT TURN ON.

Cause	Remedy
There is no power from the power cable.	Plug the power cord into the AC inlet on the projector, and plug the power cord into the power outlet. If the power outlet has a switch, make sure that it is switched on.
Attempting to turn the projector on again during the cooling process.	Wait until the cooling down process has completed.

⑦ NO PICTURE

Cause	Remedy
The video source is not turned on or connected correctly.	Turn the video source on and check that the signal cable is connected correctly.
The projector is not correctly connected to the input source device.	Check the connection.
The input signal has not been correctly selected.	Select the correct input signal with the Source key on the projector or remote control.
The lens cap is still attached to the lens.	Remove the lens cap.

⑦ BLURRED IMAGE

Cause	Remedy
The projection lens is not correctly focused.	Adjust the focus of the lens using the focus ring.
The projector and the screen are not aligned properly.	Adjust the projection angle and direction as well as the height of the unit if necessary.
The lens cap is still attached to the lens.	Remove the lens cap.

⑦ REMOTE CONTROL DOES NOT WORK

Cause	Remedy
The battery is out of power.	Replace the battery with a new one.
There is an obstacle between the remote control and the projector.	Remove the obstacle.
You are too far away from the projector.	Stand within 6 meters (19.5 feet) of the projector.

⑦ THE PASSWORD IS INCORRECT

Cause	Remedy
You do not remember the password.	Please see "Entering the password recall procedure" on page 24 for details.

Specifications

Projector specifications

 All specifications are subject to change without notice.

Optical

Projection system	Three-panels LCD system.
DMD chip	0.55" LCD (1280 x 720)
Lens	1.2x zoom
Projection screen size	23.5" ~ 300"
Lamp	140W

Electrical

Video Signal	NTSC / NTSC4.43 / PAL-B/G / PAL-M / PAL-N / SECAM / HDTV
Data Signal	XGA, SVGA, VGA, Macintosh®, HDTV (1080p, 1080i, 720p, 576p, 576i, 480p, 480i)
Max. number of display colors	16,770,000 (full color display)

Terminals

Input	Video, S-Video, Component (Y/ CB/ CR, Y/ PB/ PR), D-sub, HDMI
Output	12VDC (Max 0.5A)

General characteristics

Weight	8.8lbs/ 4.0kg+/-0.2
Power	VAC 100 - 240V, 4.0 A, 50 / 60 Hz (Automatic)
Power consumption	Max 215W
Operating temperature	0~35 C, (without condensation) at sea level
Operating humidity	10% - 90% (without condensation)
Operating altitude	0~1499m, 0~35°C
	High altitude mode: 1500~3000m 0~30°C
Storage temperature	-20°C- 60°C / -4°F to 140°F
Storage humidity	10% - 90%

Dimensions

349 x 126.8 x 295.8 mm (W x H x D)

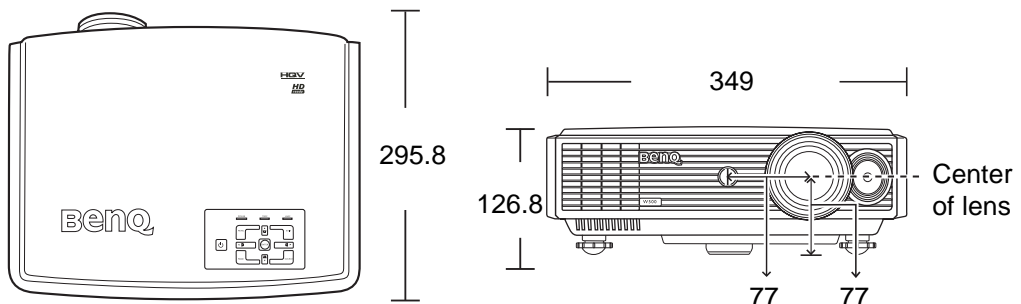

Unit: mm

Timing chart

 'V' denotes the type of input that this timing can support.

Format	Resolution	Refresh rate(Hz)	H. Freq. (KHz)	Pixel Freq. (MHz)	Comp. 1/2	S-Video/ Video	D-Sub	HDMI
720 x 400	720 x 400	70	31.469	28.322	-	-	V	V
640 x 480	640 x 480	60	31.5	25.175	-	-	V	V
		72	37.9	31.5	-	-	V	V
		75	37.5	31.5	-	-	V	V
		85	43.3	36	-	-	V	V
800 x 600	800 x 600	60	37.9	40	-	-	V	V
		72	48.1	50	-	-	V	V
		75	46.9	49.5	-	-	V	V
		85	53.7	56.25	-	-	V	V
1024 x 768	1024 x 768	60	48.4	65	-	-	V	V
		70	56.5	75	-	-	V	V
		75	60	78.75	-	-	V	V
		85	68.7	94.5	-	-	V	V
1280 x 768	1280 x 768	60	47.4	68.25	-	-	V	V
		60	47.8	79.5	-	-	V	V
		75	80	135	-	-	V	V
		85	91.1	157.5	-	-	V	V

Format	Resolution	Refresh rate(Hz)	H. Freq. (KHz)	Pixel Freq. (MHz)	Comp. 1/2	S-Video/ Video	D-Sub	HDMI
NTSC 3.58	-	59.94 / 60	15.734/ 15.75	3.58	-	V	-	-
NTSC 4.43	-	59.94 / 60	15.734/ 15.75	4.43	-	V	-	-
PAL-B/G	-	50	15.625	4.43	-	V	-	-
PAL M	-	59.94 / 60	15.734/ 15.75	3.58	-	V	-	-
PAL N	-	50	15.625	3.58	-	V	-	-
PAL 60	-	59.94 / 60	15.734/ 15.75	4.43	-	V	-	-
480/60i	720 x 487	59.94 / 60	15.734/ 15.75	-	V	-	-	V
480/60p	720 x 483	59.94 / 60	31.469/ 31.5	-	V	-	-	V
576/50i	720 x 576	50	15.625	14.75	V	-	-	V
576/50p	720 x 576	50	31.25	29	V	-	-	V
720/50p	1280 x 720	50	37.5	75.25	V	-	-	V
720/60p	1280 x 720	59.94 / 60	44.955/ 45	74.25	V	-	-	V
1080/50i	1920 x 1080	50	28.125/ 31.25	74.25/72	V	-	-	V
1080/60i	1920 x 1080	59.94 / 60	33.716/ 33.75	74.175/ 74.25	V	-	-	V
1080/24p	1920 x 1080	23.98 / 24	26.978/ 27	74.175/ 74.25	V	-	-	V
1080/50p	1920 x 1080	50	62.5/ 56.25	148.5	V	-	V	V
1080/60p	1920 x 1080	59.94 / 60	67.433/ 67.5	148.35/ 148.5	-	-	-	V

10 Warranty and Copyright information

Copyright

Copyright © 2007 by BenQ Corporation. All rights reserved. No part of this publication may be reproduced, transmitted, transcribed, stored in a retrieval system or translated into any language or computer language, in any form or by any means, electronic, mechanical, magnetic, optical, chemical, manual or otherwise, without the prior written permission of BenQ Corporation.

Disclaimer

BenQ Corporation makes no representations or warranties, either expressed or implied, with respect to the contents hereof and specifically disclaims any warranties, merchantability or fitness for any particular purpose. Further, BenQ Corporation reserves the right to revise this publication and to make changes from time to time in the contents hereof without obligation of BenQ Corporation to notify any person of such revision or changes.

*Hollywood Quality Video and HQV are trademarks of Silicon Optix Inc. Others are copyrights of their respective companies or organizations.

Warranty

BenQ warrants this product against any defects in material and workmanship, under normal usage and storage.

Proof of purchase date will be required with any warranty claim. In the event this product is found to be defective within the warranty period, BenQ's only obligation and your exclusive remedy shall be replacement of any defective parts (labor included). To obtain warranty service, immediately notify the dealer from which you purchased the product of any defects.

Important: The above warranty shall be void if the customer fails to operate the product in accordance with BenQ's written instructions, especially the ambient humidity must be in-between 10% and 90%, temperature in-between 0°C and 40°C, altitude lower than 10000 feet, and avoiding to operate the projector in a dusty environment. This warranty gives you specific legal rights, and you may have other rights which vary from country to country.

For other information, please visit www.BenQ.com.

11 Regulation statements

FCC statement

CLASS B: This equipment generates, uses and can radiate radio frequency energy and, if not installed and used in accordance with the instructions, may cause harmful interference to radio communications. However, there is no guarantee that interference will not occur in a particular installation. If this equipment does cause harmful interference to radio or television reception, which can be determined by turning the equipment off and on, the user is encouraged to try to correct the interference by one or more of the following measures:

- Reorient or relocate the receiving antenna.
- Increase the distance between the equipment and receiver.
- Connect the equipment into an outlet on a circuit different from that to which the receiver is connected.
- Consult the dealer or an experienced radio/TV technician for help.

EEC statement

This machine was tested against the 89/336/EEC (European Economic Community) for EMC (Electronic Magnetic Compatibility) and fulfills these requirements.

MIC statement

B class equipment (Household purpose info/telecommunications equipment)

This equipment has undergone EMC registration for household purpose, and can be used in any area including residential area.

WEEE directive

Disposal of Waste Electrical and Electronic Equipment by users in private households in the European Union.

This symbol on the product or on the packaging indicates that this can not be disposed of as household waste. You must dispose of your waste equipment by handing it over to the applicable take-back scheme for the recycling of electrical and electronic equipment. For more information about recycling of this equipment, please contact your city office, the shop where you purchased the equipment or your household waste disposal service. The recycling of materials will help to conserve natural resources and ensure that it is recycled in a manner that protects human health and environment

