

DIGITAL PROJECTOR

MX816ST



Features

- Native XGA (1024 x 768) Resolution
- 3000 ANSI Lumens, 13000:1 Contrast Ratio
- 0.61 Short Throw Ratio
- LAN Control; HDMI x 1, 10W Speaker
- Long Lamp Life with SmartEco™



Input and Output Terminals

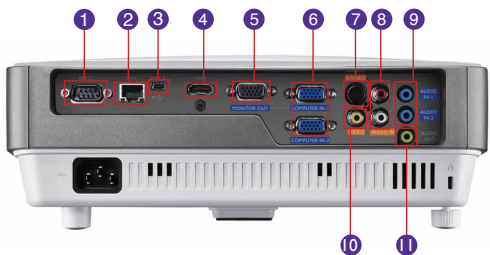

- | | |
|-----------------------------|-----------------------------------|
| 1 RS232 (DB-9pin) | 6 Computer In 1 & 2 (D-sub 15pin) |
| 2 LAN (RJ45) | 7 S-Video In (Mini DIN 4pin) |
| 3 USB (Type Mini B) | 8 Audio In L/R (RCA) |
| 4 HDMI V1.3 | 9 Audio In 1 & 2 (Mini Jack) |
| 5 Monitor Out (D-sub 15pin) | 10 Composite Video In (RCA) |
| | 11 Audio Out (Mini Jack) |

Specifications

Projection System	DLP®
Native Resolution	XGA(1024 x 768)
Brightness	3000 ANSI lumens
Contrast Ratio	13000 : 1
Display Color	1.07 Billion Colors
Lens	F=2.6, f=6.9mm
Aspect Ratio	Native 4:3 (5 aspect ratio selectable)
Throw Ratio	0.61 (78" @ 3.14f)
Image Size (Diagonal)	40~300"
Zoom Ratio	Fixed
Lamp Type	210W
Lamp Life	4000/5000/6500 hours (Normal/Eco/Smart Eco)
Keystone Adjustment	1D, Vertical ±40 degrees
Projection Offset	130% ±5%
Resolution Support	VGA(640 x 480) to UXGA(1600 x 1200)
Horizontal Frequency	31K~102KHz
Vertical Scan Rate	23~120Hz
Compatibility	HDTV Compatibility: 480i, 480p, 576i, 576p, 720p, 1080i, 1080p Video Compatibility: NTSC, PAL, SECAM 3D Compatibility: PC:120Hz Frame Sequential 3D for resolutions up to WXGA PC: 60Hz Top-bottom 3D for resolutions up to SXGA+ Video: 60Hz Frame Sequential 3D for resolutions up to 480i
Interface	Computer in (D-sub 15pin) x 2 (shared with Component) Monitor out (D-sub 15pin) x 1 HDMI (V1.3) x 1 Composite Video in (RCA) x 1 S-Video in (Mini DIN 4pin) x 1 Audio in (Mini Jack) x 2 Audio L/R in (RCA) x 1 Audio out (Mini Jack) x 1 Speaker 10W x 1 LAN (RJ45) x 1 (LAN Control) USB (Type B) x1 (Download & page up/down) RS232 (DB-9pin) x 1 IR Receiver x 2
Dimensions (WxHxD)	11.3 x 4.49 x 9.16 inches (287.3 x 114.4 x 232.6 mm)
Weight	6.17lbs (2.8kg)
Power Supply	AC 100 to 240 V, 50/60 Hz
Power Consumption	270W, Standby<1W
Audible Noise	36/29 dBA (Normal/Economic mode)
On-Screen Display Languages	Arabic/Bulgarian/ Croatian/ Czech/ Danish/ Dutch/ English/ Finnish/ French/ German/ Greek/ Hindi/ Hungarian/ Italian/ Indonesian/ Japanese/ Korean/ Norwegian/ Polish/ Portuguese/ Romanian/ Russian/ Simplified Chinese/Spanish/ Swedish/ Turkish/ Thai/ Traditional Chinese (28 Languages)
Picture Modes	Dynamic/Presentation/sRGB/Cinema/User 1/User 2
Accessories (Standard)	Remote Control w/ Battery, Power Cord (by region), User Manual CD/ Quick Start Guide, Warranty Card (by region), VGA(D-sub 15pin) Cable
Accessories (Optional)	Carry bag P/N: 5J.J4R09.001 Spare Lamp Kit 3D Glasses P/N: 5J.J0T14.011 Ceiling Mount P/N: 5J.J2K01.001 0.6 Wall Mount P/N: 5J.J4R10.001
Limited Warranty	3-Year Parts & Labor / 1-Year or 2000 hours of lamp life
UPC Code	8400460-2502-1

*Lamp life results will vary depending on environmental conditions and usage. Actual product's features and specifications are subject to change without notice.

MX816ST 01-12-12-BQus



BenQ America Corp.
15375 Barranca Parkway, Suite A-205, Irvine, CA 92618 Tel: (949) 255-9500 www.BenQ.us

BenQ is a registered trademark of BenQ Corp. DLP is a registered trademark of Texas Instruments. All rights reserved. Product names, logos, brands, and other trademarks featured or referred to in this materials are the property of their respective trademark holders. Specifications subject to change without notice.



Enjoyment Matters

MX816ST Digital Projector

Distance Chart

The screen aspect ratio is 4:3 and the projected picture is 4:3

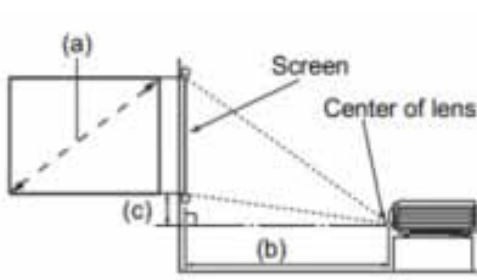

(a) Screen Size				(b) Distance from screen (inch)	(c) Vertical offset (inch)
Diagonal		W (inch)	H (inch)		
Inch	mm				
80	2032	48	64	38.9	7.2
100	2540	60	80	48.6	9.0
120	3048	72	96	58.3	10.8
150	3810	90	120	72.9	13.5
180	4572	108	144	87.5	16.2
200	5080	120	160	97.2	18.0
220	5588	132	176	106.9	19.8
240	6096	144	192	116.6	21.6
270	6858	162	216	131.2	24.3
300	7620	180	240	145.8	27.0

Wall Mount Chart

$$\text{Minimum Ceiling Height (mm)} = f + H + b + 2.36'' = 10.79'' + c$$

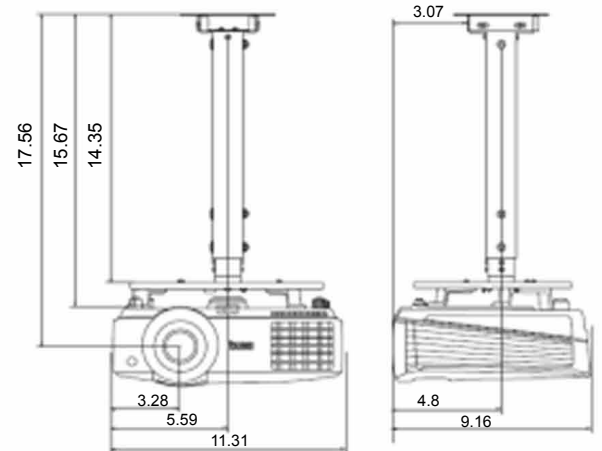
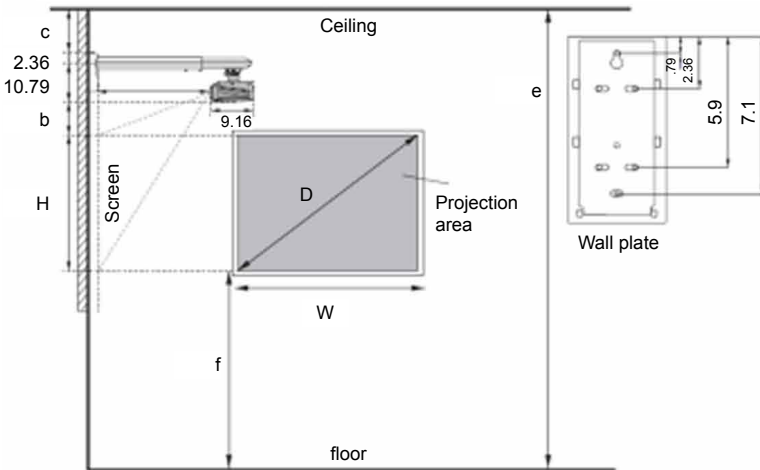

Unit: inches

Dimensions

